	GLOBAL STANDARD	Page 1 of 24
	UP - Box for indoor installations	GSTR001/2 Rev. 01

UP - Box for indoor installations

This document describes the box for indoor installations of the UP, the Remote Terminal Unit for telecontrol and supervision of Medium Voltage distribution network; it provides functional and construction requirements for the supply.

7 c i b h f] ENI = /	Elaborated by	Verified by	Approved by
Argentina			Mario Colonnello
Brazil			Victor Manuel Galvao Macedo Costa
Chile			Hans Christian Rother Salazar
Colombia			Cesar Augusto Rincon Alvarez
Iberia			Maria Avery Fernandez
Italy			Gianluca Sapienza
Peru			Roberto Leonidas Sanchez Vargas
Romania			Ivano Bonfanti

	Revision	Elaborated by	Collaborations	Verified by	Approved by
Global I&N ENI/SGS	01	Giorgio Scrosati	José Luis Calero Erika Lino	Erika Lino	Giorgio Di Lembo
Global I&N ENI/SGS	00	Giorgio Di Lembo Lilia Consiglio	C o u n t r i - e N T'	Maria Avery José Luis Calero	Giorgio Di Lembo

This document is intellectual property of Enel Spa; reproduction or distribution of its contents in any way or by any means whatsoever is subject to the prior approval of the above mentioned company which will safeguard its rights under the civil and penal codes.

It is for internal Use. Each Country can provide a translation in local language but the official reference document is this GS English version.

Revision	Data	List of modifications
00	02.11.2015	First version
01	28.07.2017	Standardization of the CM-UP support; Inserted quotes for the standard CM-UP support; Annex I added related to Argentina; Chapter 10 review, including in the supply conditions: TCA documents, manuals delivery and safety information on plate; Chapter 11 added, on safety requirements; Other minor fixes; Editorial amendments.

	GLOBAL STANDARD	Page 3 of 24
	UP - Box for indoor installations	GSTR001/2 Rev. 01

INDEX

1	ACRONYMS	4
2	INTRODUCTION	5
3	LIST OF COMPONENTS, PRODUCT FAMILY OR SOLUTIONS TO WHICH THE GS APPLIES	5
3.1	Enel Product family codes of the Indoor Cabinets	5
4	APPLICABLE LAWS, REFERENCE STANDARDS AND GLOBAL STANDARDS	8
4.1	Applicable Laws and Standards	8
4.2	Enel Global Standards quoted in the document	8
5	CONSTRUCTION CHARACTERISTICS	8
5.1	Indoor box – wall-mounted version	8
5.2	Indoor box – ceiling-mounted version.	14
6	EQUIPMENT TO BE PLACED INTO THE CABINET	18
6.1	PSBC	18
6.2	UE	18
6.3	Batteries	18
6.4	Communication module	18
6.5	Ambient temperature probe	19
6.6	Cables and terminal board	19
7	TESTING AND INSPECTION	21
7.1	Type tests	22
7.1.1	Visual inspection.....	22
7.1.2	Check of all connections.....	22
7.1.3	Mechanical tests.....	22
7.2	Acceptance tests	23
8	FASTENING SYSTEMS	23
8.1	Wall-mounting	23
8.2	Ceiling-mounting	24
9	AMBIENT OPERATING CONDITIONS	24
10	SUPPLY REQUIREMENTS	24
10.1	TCA documents and Manuals	24
10.1.1	TCA documents.....	24
10.1.2	Manuals.....	24
10.1.3	Safety warnings on Plate.....	24
11	SAFETY REQUIREMENTS	24

	GLOBAL STANDARD	Page 4 of 24
	UP - Box for indoor installations	GSTR001/2 Rev. 01

1 ACRONYMS

CM	Ceiling-Mounted
CPE	Customer Premises Equipment
DFPI	Directional Fault Passage Indicator
IC	Customer Interface device
LVI	Line Voltage Indicator
LVCB	Low Voltage Circuit Breaker
PSBC	Power Supply Battery Charger
RGDAT	directional fault passage and voltage loss indicator
RGDM	directional fault passage indicator with measuring acquisition
Recloser	switch breaker with an integrated control module
RTU	Remote Terminal Unit for the remote control of the secondary substations
SD	Switch Disconnecter
TB	Terminal Board
UE	Processing Unit of the RTU
WM	Wall-Mounted

	GLOBAL STANDARD	Page 5 of 24
	UP - Box for indoor installations	GSTR001/2 Rev. 01

2 INTRODUCTION

Enel standardized MV remote control solution includes a Remote Terminal Unit (RTU) and, optionally, as many fault detectors as the Line Out switches.

The components and elements of a MV/LV substation that can be remote controlled include MV and LV switch-disconnectors, circuit breakers and reclosers. The Global Standard GSTR001 describes the standardized Remote Terminal Unit (RTU), also called UP, which can be used to remote control MV/LV substations.

This document describes the box for the Remote Terminal Unit designed for indoor (MV/LV substation and MV distribution substation) applications.

3 LIST OF COMPONENTS, PRODUCT FAMILY OR SOLUTIONS TO WHICH THE GS APPLIES

Two versions of the outdoor container have been defined:

- < Wall-mounted version (WM-UP, as shown in Figure 1, Figure 2),
- < Ceiling-mounted version (CM-UP, as shown in Figure 3)

Each one corresponds to a different product family code.

3.1 Enel Product family codes of the Indoor Cabinets

Global Product Family Code	Device Code	Description	Reference Global Standard	Included in the Global Product family code
519530		Complete UP kit for Indoor application, mounted in the Wall-mounted indoor cabinet container equipped with UE8	GSTR001/1 GSTR001/2	PSBC UE8 WM-UP8
519532		Complete UP kit for Indoor application, mounted in the Wall-mounted indoor cabinet container, equipped with UE16 (Processing Unit Device capable to telecontrol for 16 switchgears)	GSTR001/1 GSTR001/2	PSBC UE16 WM-UP8
	CM-UP	Ceiling-mounted indoor cabinet container for Remote Terminal Unit	GSTR001/2	
519544	WM-UP	Wall-mounted indoor cabinet container for indoor Remote Terminal Unit	GSTR001/2	

For a comprehensive list of UP family codes see the Global Standard GSTR001/1.

In the figures below, the different Indoor UP solutions:

- **Figure 1** Wall-mounted indoor cabinet container (WM-UP) equipped with UE8 (Processing Unit Device capable to telecontrol for 8 switchgears)
- **Figure 2** Wall-mounted indoor cabinet container (WM-UP) equipped with UE16 (Processing Unit Device capable to telecontrol for 16switchgears)
- **Figure 3** Ceiling-mounted indoor cabinet container (CM-UP)

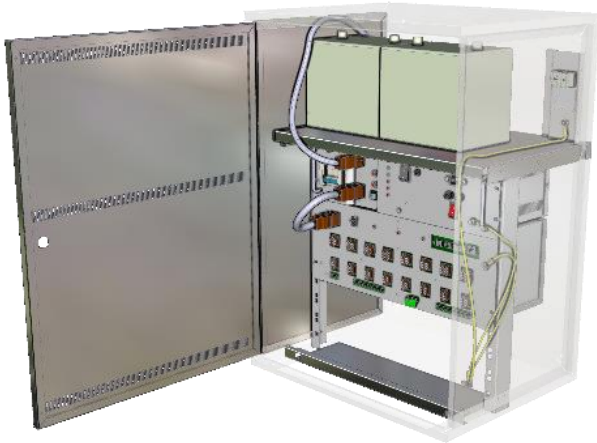

Figure 1 – WM-UP8

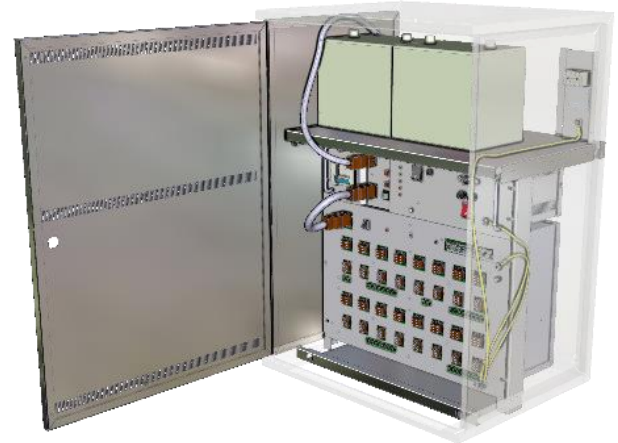

Figure 2 – WM-UP16

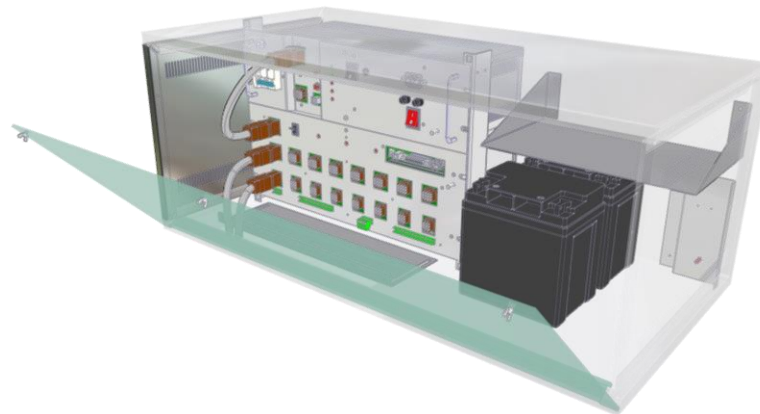



Figure 3 – CM-UP

	GLOBAL STANDARD	Page 7 of 24
	UP - Box for indoor installations	GSTR001/2 Rev. 01

Description	Global Product Family Code	Argentina	Brazil	Chile	Colombia	Italy	Peru	Romania	Spain
Complete UP kit for Indoor application, mounted in the Wall-mounted indoor cabinet container	519530	0131-0403 ¹		6808327	6810358	519530	6810358	519530	510255
Complete UP kit for Indoor application, mounted in the Ceiling-mounted indoor cabinet container									510257

In the different solutions available, the following table shows the components included in the supply.

Accessories	Solution	Description	Reference Global Standard	Supplied
PSBC	WM-UP8/WM-UP16/ CM-UP	Power supply/ battery charger of the RTU, switchgears and auxiliary devices (modem, router, etc.) with accessories	GSTR001/1	Yes
UE8	WM-UP8/ CM-UP	Processing Unit Device capable to telecontrol for 8 switchgears with accessories	GSTR001/1	Yes
UE16	WM-UP	Processing Unit Device capable to telecontrol for 16 switchgears with accessories	GSTR001/1	Yes
Batteries	WM-UP8/WM-UP16/ CM-UP	Couple of 12V batteries for remote control secondary substations	GSCB001	No
GSM/GPRS Modem	WM-UP8/WM-UP16/ CM-UP	DCE for the remote connection		No
PSBC-BATT/TB-AUX	WM-UP8/WM-UP16/ CM-UP	Connection cable among PSBC Batteries and TB-AUX		Yes
TB-AUX	WM-UP8/WM-UP16/ CM-UP	Terminals board for the auxiliary power supplies		Yes

¹ The Complete UP kit for Indoor application in Argentina corresponding to this product family code differs to the Global solution in the cabinet, as described in the Annex I to GSTR001/2

	GLOBAL STANDARD	Page 8 of 24
	UP - Box for indoor installations	GSTR001/2 Rev. 01

CM-S	CM-UP	Support for ceiling-mounting	Yes
Temperature probe	WM-UP8/WM-UP16/ CM-UP	Probe for ambient temperature measurement	Yes

4 APPLICABLE LAWS, REFERENCE STANDARDS AND GLOBAL STANDARDS

4.1 Applicable Laws and Standards

IEC 60068-2-6:2007	Environmental testing - Part 2-6: Tests - Test Fc: Vibration (sinusoidal)
IEC 60068-2-64:2008	Environmental testing - Part 2-64: Tests - Test Fh: Vibration, broadband random and guidance

4.2 Enel Global Standards quoted in the document

GSTR001/1	Remote Terminal Unit for secondary substations (UP)
GSTR001/2	UP - Box for indoor installations
GSTR001/3	UP - Box for Outdoor installations
GSCG002	Technical Conformity Assessment
GSCB001	12V Accumulators for remote control secondary substations
GSTP001	RGDAT-A70

5 CONSTRUCTION CHARACTERISTICS

5.1 Indoor box – wall-mounted version

The cabinet container is a 19" rack, accessible from

The metallic container must be provided with a 6 MA grounding bolt (on the right side) to which ground and the +24 V_{DC} power supply will be connected.

The container must be fixed to the wall through dowels of 10 mm diameter (each cabinet must include the drilling jig). The rear of the cabinet must be equipped with spacers, in order to create a space between the fixing panel and the wall.

The front door must be hinged on a side, and equipped with a door-lock without key and of ventilation slots for air circulation.

Two shelves are located in the container, as shown in Figure 4

	GLOBAL STANDARD	Page 9 of 24
	UP - Box for indoor installations	GSTR001/2 Rev. 01

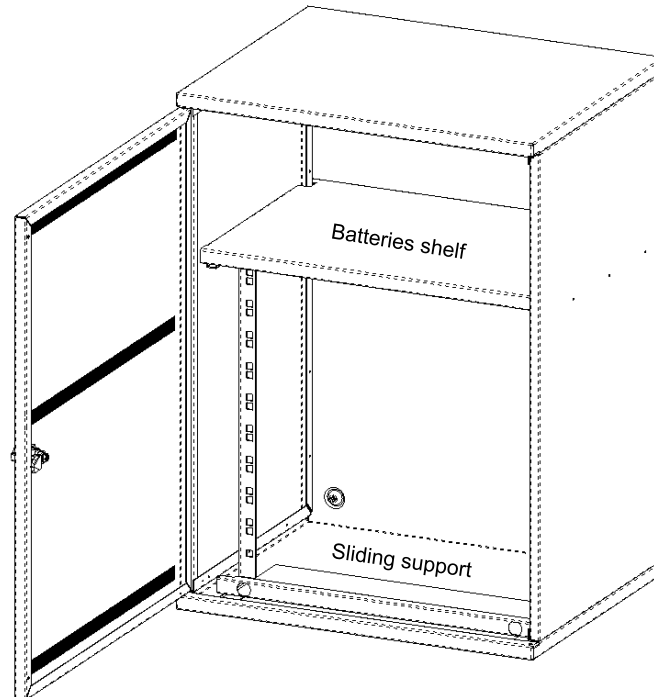

Figure 4 – WM-UP8/UP16 Cabinet container overview

On the upper side of the cabinet, there must be a case with a height equal to 5U (222,25 mm), borders not included, utilized in order to contain two batteries, in compliance with the global specifications on batteries for secondary substations.

Inside this case, a terminal board must be located, for the connection of the 12 V_{DC} (ungrounded) and 24 V_{DC} (with positive grounded) auxiliary supplies. The terminal board must be easily accessible from the front (it cannot be positioned at the rear of the container), even if the batteries are in the case: it can be positioned on a support, on the left or right side of the cabinet (other solutions can be accepted, if agreed upon in advance with ENEL). The support must not have any protruding or sharp edges and allow for the installation and replacement operations on the batteries to be executed in complete safety.

The DCE will be housed outside the container, or, rather, on the side of the batteries, in correspondence of the terminal board of the auxiliary supplies.

The second shelf, which represents the bottom of the cabinet container, must be provided with a sliding support for cable fixing. The opening clearance must be sufficient in order to ensure either the fastening of all of the cable for field interface, the input AC power supply, or the power supply to the DCE, etc. The removable support must be equipped with a protective sealing and fixing screws.

Figure 6, Figure 7, and Figure 8 provide indicative dimensions and sizes of the wall-mounted cabinet container.

The maximum dimensions for the WM-UP box are shown in Figure 5 – Maximum dimensions for the WM-UP cabinet container

	GLOBAL STANDARD	Page 10 of 24
	UP - Box for indoor installations	GSTR001/2 Rev. 01

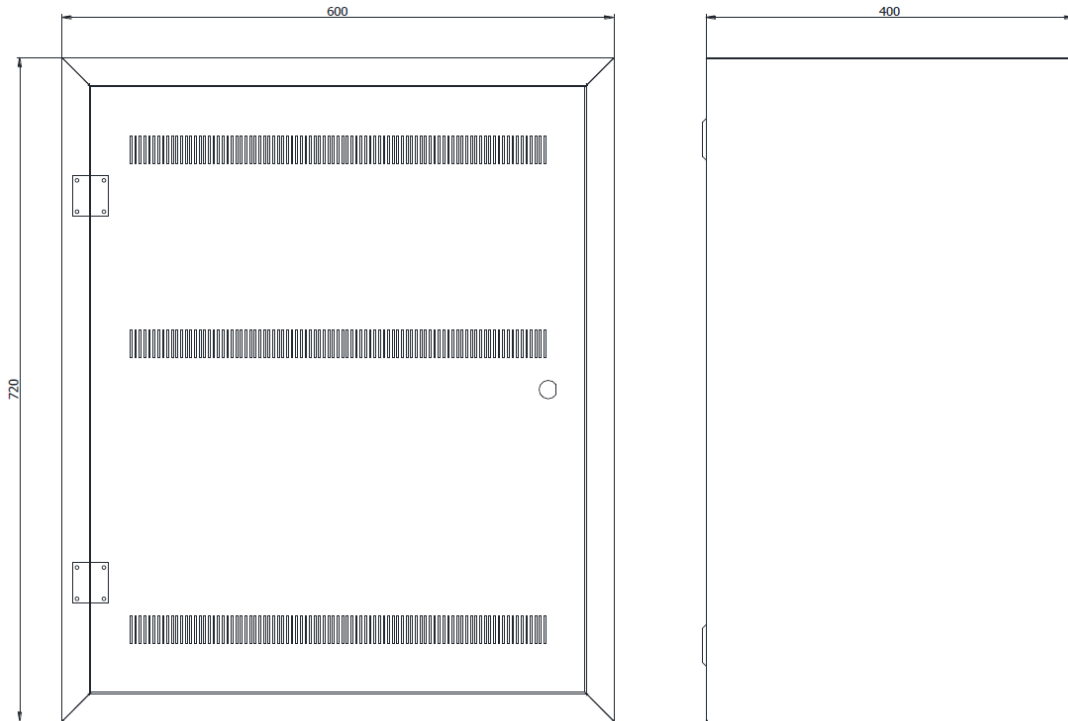

Figure 5 Ę Maximum dimensions for the WM-UP cabinet container

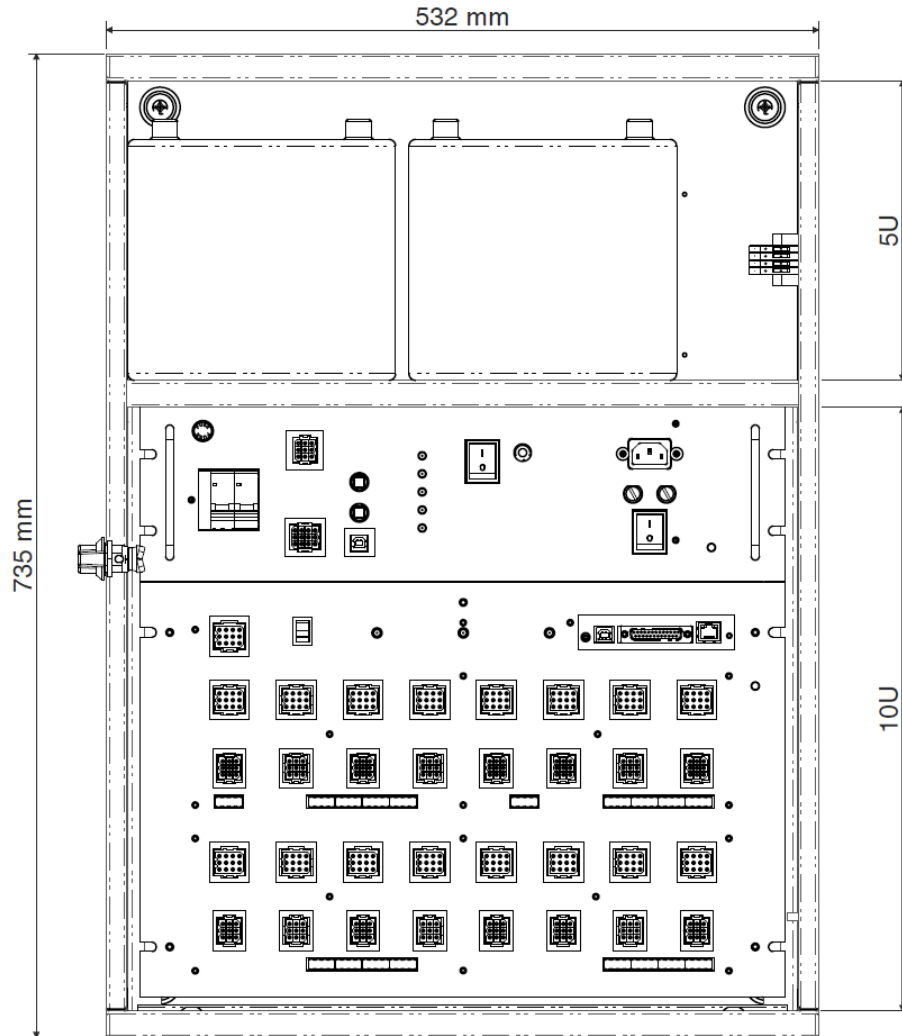
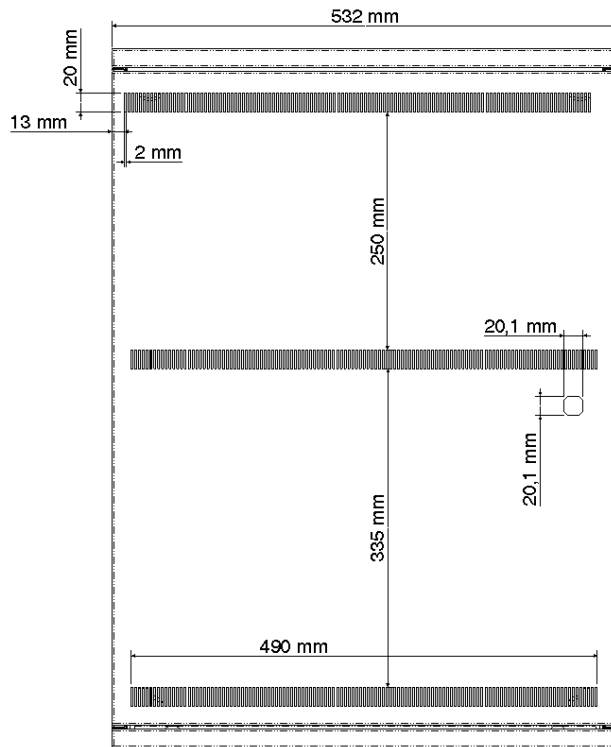

Figure 6 – Front view of the indoor WM-UP8/UP16 Cabinet container (with UE16 version mounted inside)
(indicative dimensions)



FRONT



TOP

SIDE (section)

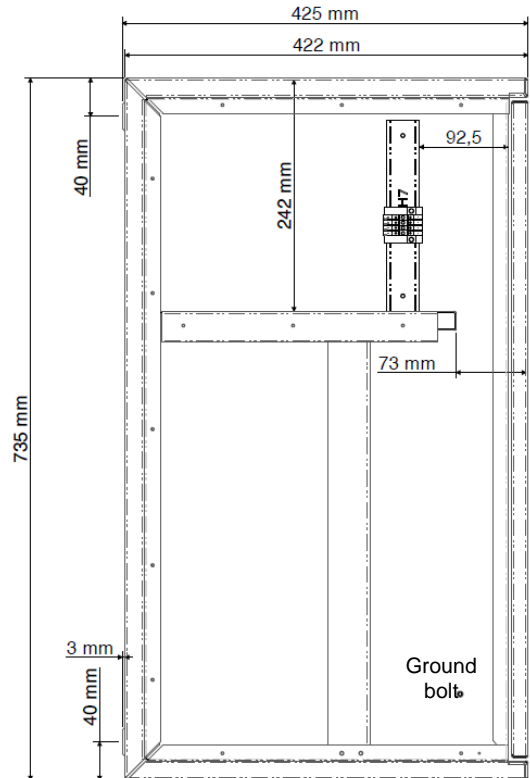

BOTTOM

	GLOBAL STANDARD	Page 13 of 24
	UP - Box for indoor installations	GSTR001/2 Rev. 01

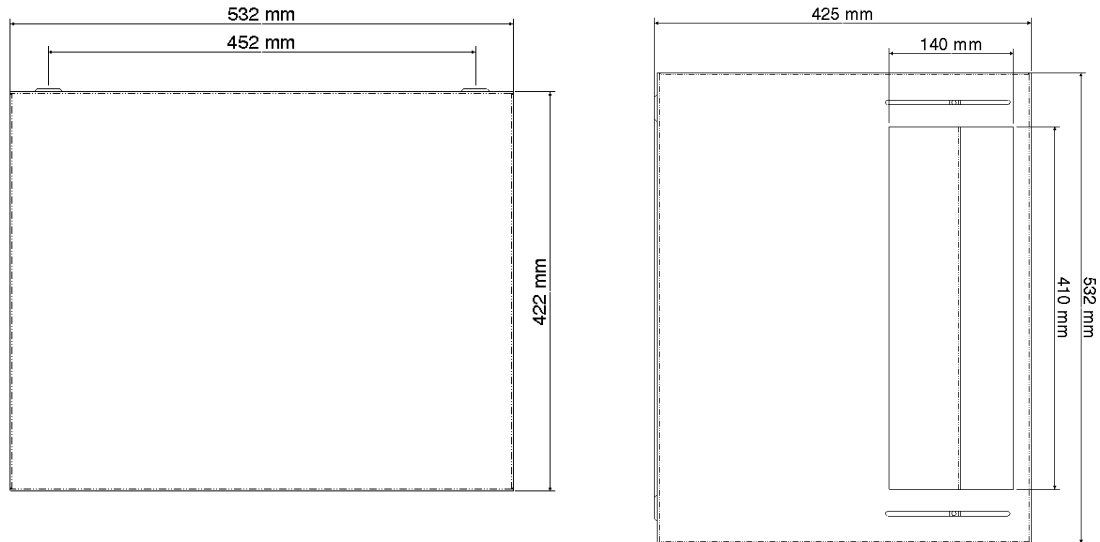

Figure 7 – Front, Side, Top and Bottom views of the indoor WM-UP8/UP16 Cabinet container (indicative dimensions)

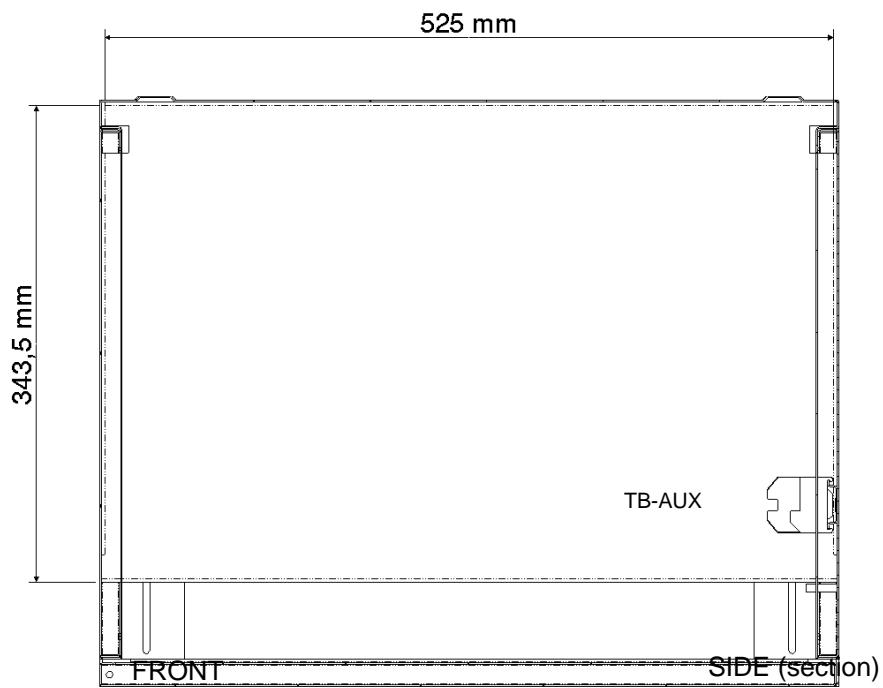

Figure 8- Battery shelf (section)

	GLOBAL STANDARD	Page 14 of 24
	UP - Box for indoor installations	GSTR001/2 Rev. 01

5.2 Indoor box – ceiling-mounted version.

The ceiling-mounted version is intended for secondary substations with reduced space mounting requirements.

The cabinet container must be built for ceiling fixing. The fixing structure must be designed for even distribution of the UE weight.

The cabinet container is designed in order to host the UE8 version only.

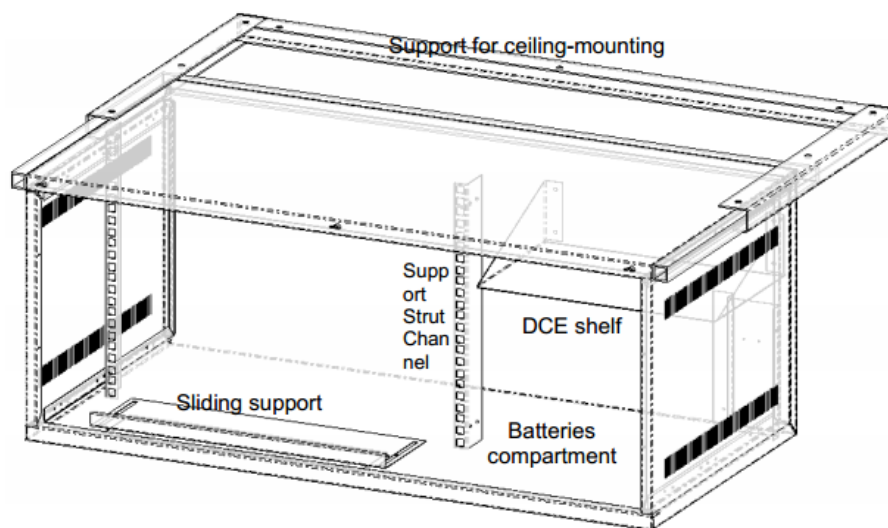

Figure 9 – Overview of the CM-UP outdoor cabinet container (example)

The cabinet container is arranged on two columns, accessible from the front by an opening door, of dimensions equal to those shown in Figure 9.

The container must ensure an IP3X degree of protection, except for the bottom.

The front door, also metallic, must be hinged on bottom side allowing the opening of the door by 180°. The front door must be equipped with a door-lock without key and with slots of ventilation for air circulation.

	GLOBAL STANDARD	Page 15 of 24
	UP - Box for indoor installations	GSTR001/2 Rev. 01



Figure 10 - Door-lock without key for the CM-UP

The metallic cabinet must be provided with a 6MA grounding bolt (on the right side) to which ground and the +24 VDC power supply will be connected.

Batteries are hosted on the bottom of the cabinet container, into an appropriate compartment, on the right side. A terminal board must be located in the rear left side, for the connection of the 12 V_{DC} (ungrounded) and 24 V_{DC} (with positive grounded) auxiliary supplies.

A shelf for the housing of the DCE must be fixed above the batteries.

The cabinet container is suitable for ceiling-mounting through the fastening system proposed in the following chapter 7, interchangeable for all providers in order to reduce the works in secondary substations with reduced space.

The following figures provides the dimension and the main sizes of the ceiling-mounted cabinet container.

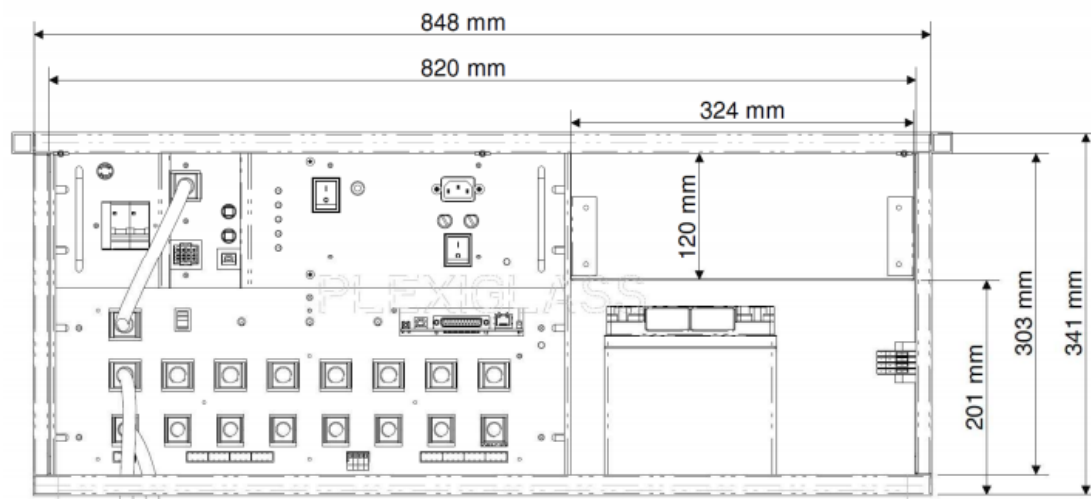

Figure 11 Ë Front view of the indoor CM-UP Cabinet container, quotes are indicative: must be guaranteed compatibility with the CM-UP support, figure 11

	GLOBAL STANDARD	Page 16 of 24
	UP - Box for indoor installations	GSTR001/2 Rev. 01

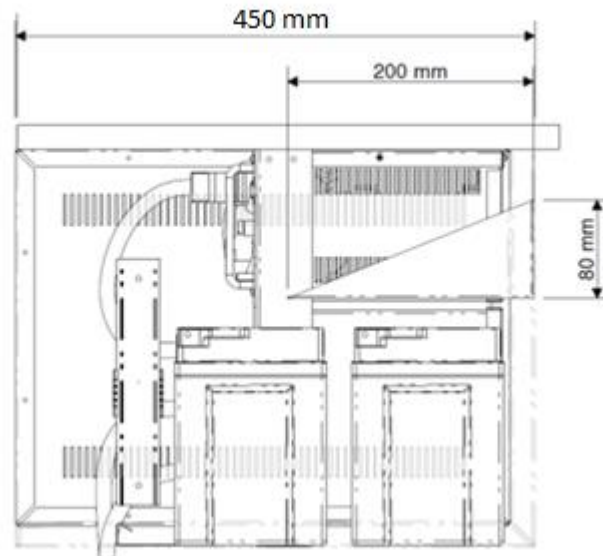

Figure 12 – Side view of the indoor CM-UP Cabinet container

The outer edge of the upper part of the container must be reinforced with a squared steel profile (minimum size 20mm), fixed to the structure of the container. This profile must be complementary to that of the ceiling fixing support.

	GLOBAL STANDARD	Page 17 of 24
	UP - Box for indoor installations	GSTR001/2 Rev. 01

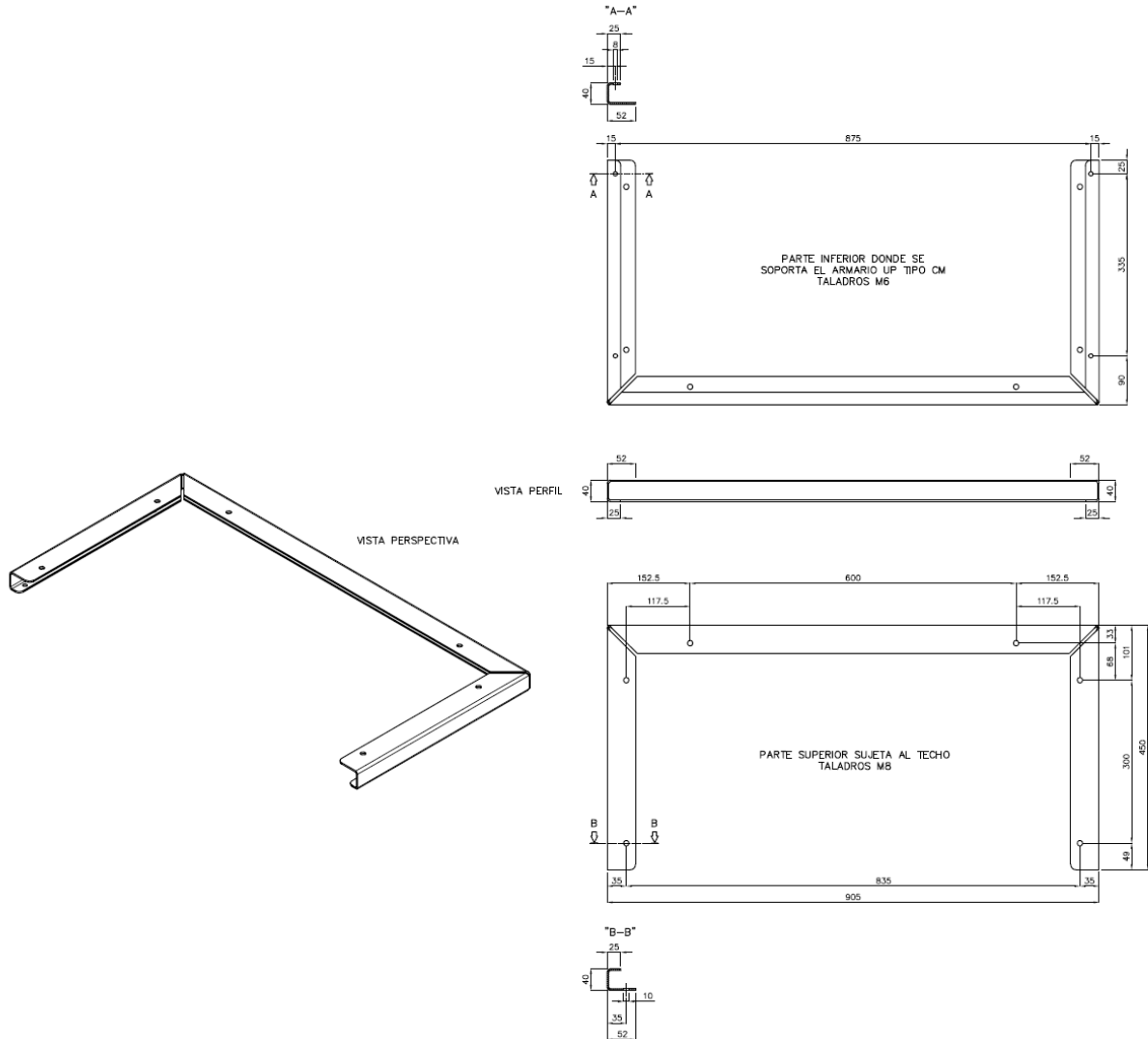



Figure 13 – CM-UP dimensions, to guarantee interchangeability

	GLOBAL STANDARD	Page 18 of 24
	UP - Box for indoor installations	GSTR001/2 Rev. 01

6 EQUIPMENT TO BE PLACED INTO THE CABINET

The cabinet is designed to host the equipment described in the Global Standard GSTR001/1.

According to different specific applications, the Indoor UP can be assembled in different configurations, containing all of or a subset of the following components:

- < Power supply/battery charger (PSBC) with accessories;
- < UE (either UE8 or UE16 versions) with accessories;
- < Batteries;
- < Communication module (DCE);
- < Ambient temperature probe;
- < Terminal board (TB-AUX).

6.1 PSBC

The UP Battery Charger/Power supply, called PSBC, is described into the Global Standard GSTR001/1.

The PSBC has to be assembled on a 19" rack, with screws and cage bolts included in the supply. The overall height is equal to 3U.

6.2 UE

The UP Processing Unit Device, available in two different versions (UE8, capable to manage up to 8 switchgears, and UE16, capable to manage up to 16 switchgears), is described into the specification GSTR001/1.

The UE8 has to be assembled on a 19" rack, with screws and cage bolts included in the supply. The overall height is equal to 4U

The UE16 has to be assembled on a 19" rack, with screws and cage bolts included in the supply. The overall height is equal to 7U

6.3 Batteries

The batteries must be compliant with the Global Standard GSCB001 and they shall be housed inside a proper compartment, as shown in the Figures of the previous chapters of this specification.

6.4 Communication module

This module is an integrated device, which can be constituted by either a GSM/GPRS modem or a CPE device, connected to either the UE8 or other Router interfaces, via the standard serial interface. The device allows the connection of the RTU to the Central System, through various possible communication networks.

The module is powered via the 12V_{DC} output, provided for on purpose and derived from the TB-AUX terminal board.

	GLOBAL STANDARD	Page 19 of 24
	UP - Box for indoor installations	GSTR001/2 Rev. 01

6.5 Ambient temperature probe

The RTU is equipped with a PT100 type probe (included in the supply), which measures the ambient temperature of the substation, and is connected to the appropriate 4-wire measurement input, namely T_{amb} , by means of a suitable cable (in the supply) of a length equal to 2 m.



The probe shall have the following characteristics:

- < PT100 type probe, compliant with IEC 60751;
- < temperature range from -25° to $+75^{\circ}$ C;
- < 4-wire connection;
- < Aerated shaped box for wall-mounting, for indoor use (see figure on the left).

The wires and the relative terminal board serigraphy on the UE must report a coloring rule (RED/WHITE), preventing an error-free cabling.

6.6 Cables and terminal board

The terminal board of the auxiliary supplies (TB-AUX) must be mounted on a DIN rail (22mm length, 7mm height), close to the batteries, and must be provided with the pre-wired connection cable to the PSBC (Table 1, Table 2 and Figure 15).

It can be installed on the right or on the left side of the box. The terminal boards to be terminal block and provided with fuses. Figure 14 shows the detail of the terminals for the connection of the power supplies and the distribution to other devices. The negative terminals of the power supplies (nr.1 at 12V and nr. 3 at 24V) will be equipped with replaceable 2.5A fuses, on the load side.

	GLOBAL STANDARD	Page 20 of 24
	UP - Box for indoor installations	GSTR001/2 Rev. 01



Figure 14 – Supply terminals for the distribution of the auxiliary voltages.
The NEGATIVE poles must be equipped with a 2.5A fuse

All of the terminals of this board must be provided with a screw tightening, for all of the cables with a section equal to 1,5mm².

Besides the supply terminal blocks, the rail should allocate the communication device if mounted inside the box.

Pin	Name	Description
1	+ Batt	Battery positive terminal (+24 V _{DC})
2	+ Batt	Battery positive terminal (+24 V _{DC})
3	-Batt	Battery negative terminal (-24 V _{DC})
4	-Batt	Battery negative terminal (-24 V _{DC})
5	+A	Auxiliary power supply
6	-A	Auxiliary power supply
7	+12 V _{DC}	DCE power supply(+12 V _{DC})
8	-12 V _{DC}	DCE power supply(-12 V _{DC})
9	-	-

Table 1 Ę Pinout (floating and fixed part of the 9 pin connector, power supply side)

All of the terminals must be provided with a screw tightening for cables with a section equal to 1,5 mm². the connections to the battery poles, red for the positive and black for the negative, must have: a section

	GLOBAL STANDARD	Page 21 of 24
	UP - Box for indoor installations	GSTR001/2 Rev. 01

3mm² (2x1,5 mm²), a length 80cm and, on the battery side, a collar label indicating the respective polarity and ring terminal connector for screw size M8 assembled in factory.

Pin	Name	Description
1	+12 V _{DC}	DCE power supply (+12V _{DC})
2	-12 V _{DC}	DCE power supply (-12 V _{DC})
3	+ A	Power supply (+24 V _{DC})
4	-A	Power supply (-24 V _{DC})

Table 2 Ę Terminal board of the auxiliary supplies

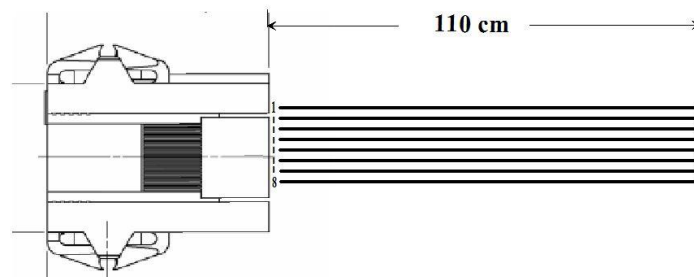



Figure 15 Ę Connection cable among PSBC, batteries and terminal board of the RTU cabinet container

The grounding braids (4 in total, of equivalent section equal to minimum 6 mm²), for the connection of the grounding bolts of the individual panels with the grounding bolt which is placed on the container, are included in the supply:

- 3 of opportune length, which includes the cable terminals, of equivalent section equal to minimum 6 mm², at both ends:
 - Connection of the battery compartment- bolt on the right side of the container;
 - Connection of the power supply- bolt on the right side of the container;
 - Connection of the UE - bolt on the right side of the container;
- 1 of opportune length, for the grounding connection of the + 24V_{DC}, including cable terminals, of equivalent section equal to minimum 6 mm², at one end only.

7 TESTING AND INSPECTION

The testing and certification process for the UP and Its components must be executed according to Enel Global Standard **GSCG002 - Technical Conformity Assessment**. That Global Standard describes the procedures for "technical conformity assessment" (directly or indirectly) to all Enel Global Infrastructure and Networks Countries.

	GLOBAL STANDARD	Page 22 of 24
	UP - Box for indoor installations	GSTR001/2 Rev. 01

Before starting the supply, the UP and its components according to GSCG002 prescriptions.

In addition to the tests prescribed in the GSTR001/1, the following tests must be executed:

- ◁ Type tests, with the aim to verify the perfect compliance of a production item with the technical specifications detailed in the present document;
- ◁ Acceptance tests, with the aim to control the essential characteristics of each item of the supply.

7.1 Type tests

The supplier must keep and provide ENEL access to the documentation which certify the success of the execution of the type tests.

7.1.1 Visual inspection

It is mandatory to verify the absence of visible manufacturing defects, the accuracy of construction, the compliance of the dimensions of the cabinet container with those indicated in the present specification, as well as the prescribed IP degree of protection.

7.1.2 Check of all connections

All of the connections of the terminal board must be verified.

The continuity between the TB-AUX terminals and the corresponding pins of the supply cable must be verified, in particular.

7.1.3 Mechanical tests

The tests to be executed on the cabinet container, as well as the methodology of the execution of these tests, are described within the standards recalled in the following table.

TEST	DESCRIPTION	REMARKS
STATIONARY VIBRATION (SINUSOIDAL)	<ul style="list-style-type: none"> ◁ Displacement amplitude (mm) : 0,75 ◁ Acceleration amplitude (m/s²) : 10 ◁ Frequency range (Hz): 10-500 ◁ Duration: 5 cycles per axis ◁ Fixing points: those of the standard mounting structure, considering the UP full equipped without batteries. ◁ Acceptance criteria: Correct operation of the device during the test (e.g. execution of open/close commands on a switch) 	Reference standard: EN 60068-2-6 (method Fc)
STATIONARY VIBRATION (RANDOM)	<ul style="list-style-type: none"> ◁ Spectrum A.1 "Tran Tab.A2 – Category 2 (EN 60068-2-64) ◁ Duration: 0.5 hours per axis (3 axis) ◁ Fixing points: as in standard shipping position without package. ◁ Acceptance criteria: No damage of the device 	Reference Standard: EN 60068-2-64 (method Fh) Category: 2 (transportation-water, trailers, lorries, in areas with well developed road systems)

These tests must be executed with all panels supplied mounted inside the Box, reproducing:

- ◁ **The operation condition in case of sinusoidal vibrations**

	GLOBAL STANDARD	Page 23 of 24
	UP - Box for indoor installations	GSTR001/2 Rev. 01

Sinusoidal vibration tests (IEC 60068-2-6) must be performed on the assembled device, in normal operation conditions and mechanical fixation, with the device in operation.

◁ **The transport conditions in case of random vibrations**

Random vibration tests (IEC 60068-2-64) must be performed on the assembled device, in the same condition as the device will be shipped, and using mechanical fixation methods allowed by IEC 60068-2-64.

7.2 Acceptance tests

Within the overall set of type tests, a subset of tests will be selected (i.e. the functionality of the thermoregulation system), mandatory for the acceptance of each specimen of supply.

For each item supplied, a certificate must be provided, which attests to the success in the execution of the acceptance test.

8 FASTENING SYSTEMS

8.1 Wall-mounting

The container is suitable for wall-mounting by dowels of diameter equal to 10 mm (each container must be provided with the drilling jig). The rear of the container must be provided with appropriate spacers, as detailed in Figure 16.

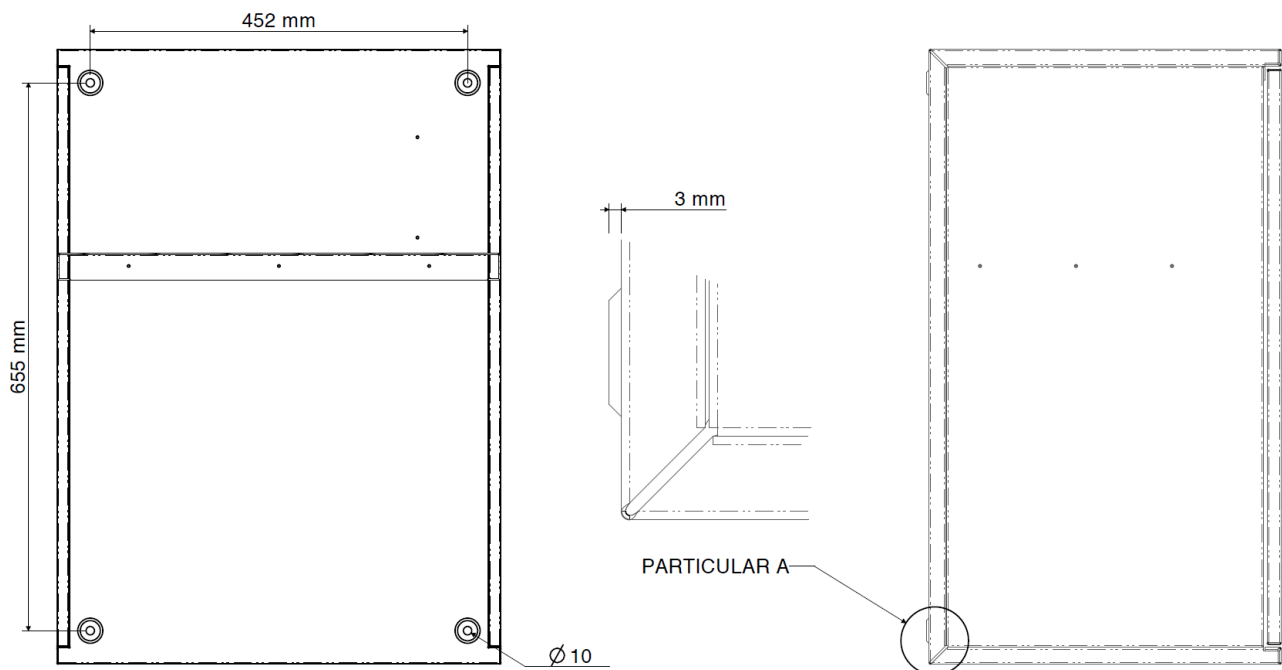



Figure 16 Ě wall-mounting details

	GLOBAL STANDARD	Page 24 of 24
	UP - Box for indoor installations	GSTR001/2 Rev. 01

8.2 Ceiling-mounting

The container must be fixed to the ceiling by a C-section steel profile support, previously fixed with dowels of appropriate size. The container will be inserted into the support and fixed by screws to the support itself.

9 AMBIENT OPERATING CONDITIONS

The apparatus provided must be in compliance with the operating conditions listed below:

- < Ambient temperature limit in the range of $-10 \div 55$ °C;
- < Atmospheric pressure in the range of $70 \div 106$ kPa;
- < Humidity limit of 93% at the max ambient temperature;
- < Storage temperature in the range of $-25 \div 70$ °C.

10 SUPPLY REQUIREMENTS

10.1 TCA documents and Manuals

10.1.1 TCA documents

The Enel technical organization unit in charge of the Technical Conformity Assessment of the device will supervise the technical documentation and the execution of the functional tests required to receive the "Statement of Conformity" in accordance with the prescriptions of the GSCG002.

10.1.2 Manuals

The supplier shall provide all the end-user documentation manuals of the UP and its components (e.g. operation, maintenance and installation manual, overall dimensional drawings, plate drawing, product colored pictures, etc). The information shall be provided on digital support.

All the manuals shall be in the local language of the device destination country.

10.1.3 Safety warnings on Plate

The safety warnings required in the plate of the UP Box and its components must be written in the local language of the UP destination Country.

11 SAFETY REQUIREMENTS

Each component of the RTU, including the non-electrical ones, must be in compliance with all of the current safety regulations (where applicable).