

| | | |
|---|---|-----------------------------|
|  | GLOBAL STANDARD | Page 1 of 51 |
| | Remote Terminal Unit for secondary substations (UP) | GSTR001/1 Rev. 01 |

This document describes the outdoor installations of the UP, the Remote Terminal Unit for telecontrol and supervision of Medium Voltage distribution network; it provides functional and construction requirements for the provision

| C o u n t r i e s | Elaborated by | Verified by | Approved by |
|-------------------|---------------|-------------|--|
| Argentina | | | Mario Colonnello |
| Brazil | | | Victor Manuel Galvao Macedo Costa |
| Chile | | | Hans Christian Rother Salazar |
| Colombia | | | Cesar Augusto Rincon Alvarez |
| Iberia | | | Maria Avery Fernandez |
| Italy | | | Gianluca Sapienza |
| Peru | | | Roberto Leonidas Sanchez Vargas |
| Romania | | | Ivano Bonfanti |

| | Revision | Elaborated by | Collaborations | Verified by | Approved by |
|---------------------------------|----------|-------------------------------------|----------------|---------------------------------|------------------|
| Global I&N – NTI/SGS | 01 | Giorgio Scrosati | Erika Lino | Erika Lino | Giorgio Di Lembo |
| Global I&N – NTI/SGS | 00 | Giorgio Di Lembo Lilia Consiglio | | Maria Avery José Luis Calero | Giorgio Di Lembo |

This document is intellectual property of Enel Spa; reproduction or distribution of its contents in any way or by any means whatsoever is subject to the prior approval of the above mentioned company which will safeguard its rights under the civil and penal codes.

It is for internal Use. Each Country can provide a translation in local language but the official reference document is this GS English version.

| Revision | Data | List of modifications |
|----------|------------|---|
| 00 | 02.11.2015 | First version |
| 01 | 08.08.2017 | Chapter 4: details have been added about the components included in the supply and Enel Product Family codes; Paragraph 5.2.4 the compatibility of the programming and configuration software with Windows 10 64bit has been included; Paragraph 8.1.8 added to clarify the mechanical tests requirements; Chapter 8 has been modified to include the Technical Conformity Assessment compliancy; Major review of Chapter 9 including in the supply conditions: TCA documents, manuals delivery and safety information on plate; Other minor fixes; Editorial amendments. |

| | | |
|---|---|-----------------------------|
|  | GLOBAL STANDARD | Page 3 of 51 |
| | Remote Terminal Unit for secondary substations (UP) | GSTR001/1 Rev. 01 |

INDEX

| | | |
|----------|--|-----------|
| 1 | ACRONYMS | 5 |
| 2 | APPLICABLE LAWS, REFERENCE STANDARDS AND ENEL STANDARDS | 6 |
| 2.1 | Applicable Laws and Standards..... | 6 |
| 2.2 | Enel Global Standards quoted in the document..... | 7 |
| 3 | INTRODUCTION..... | 8 |
| 4 | LIST OF COMPONENTS, PRODUCT FAMILY OR SOLUTIONS..... | 9 |
| 4.1 | Components of the Remote terminal Unit for Secondary substation in the configurations available..... | 9 |
| 4.2 | Enel Product family codes of the components..... | 9 |
| 4.3 | Enel Product family codes of the components adopted in each Company within Enel Group..... | 10 |
| 4.4 | List of components, product family and solutions to which the Global Standard applies | 10 |
| 5 | TECHNICAL CHARACTERISTICS OF THE UE..... | 11 |
| 5.1 | Construction characteristics | 11 |
| 5.2 | UE Functions | 12 |
| 5.2.1 | Chronological recording of fault current flows | 12 |
| 5.2.2 | Measurements | 13 |
| 5.2.3 | Faulty branch selection | 13 |
| 5.2.4 | Auxiliary functions | 13 |
| 5.2.4.1. | Communication | 13 |
| 5.2.4.2. | Diagnostics | 13 |
| 5.2.4.3. | Date/time clock function..... | 13 |
| 5.2.5 | Configuration and Programming | 13 |
| 5.2.5.1. | Configuration uploading | 14 |
| 5.2.5.2. | Downloading of the firmware | 14 |
| 5.3 | UE technical details..... | 14 |
| 5.3.1 | Connectors | 15 |
| 5.3.2 | Input terminals | 16 |
| 5.3.3 | Power supply | 16 |
| 5.3.4 | Remote controls..... | 16 |
| 5.3.5 | Remote signals | 17 |
| 5.3.6 | Measurements | 18 |
| 5.3.7 | Data buffering mode | 18 |
| 5.3.8 | Diagnostics | 19 |
| 5.3.9 | Features of the date-time clock..... | 19 |
| 6 | TECHNICAL CHARACTERISTICS OF THE PSBC..... | 19 |
| 6.1 | PSBC construction characteristics..... | 20 |
| 6.2 | PSBC electrical characteristics | 20 |
| 6.3 | Control of the mains, power supply and battery voltages | 22 |
| 6.3.1 | Test of the battery efficiency | 22 |
| 6.3.2 | Specification of the DCE power supply section..... | 23 |
| 6.3.3 | Configuration, signaling and protection devices..... | 24 |
| 7 | COMMUNICATION PROTOCOLS AND TRANSMISSION EQUIPMENT..... | 26 |
| 7.1 | IEC 60870-5-101 protocol..... | 26 |
| 7.2 | IEC 60870-5-104 protocol..... | 27 |
| 7.3 | Transmission equipment (DCE) | 27 |
| 7.3.1 | GSM/GPRS modem..... | 27 |
| 7.3.1.1. | Physical interface to an external modem | 27 |
| 7.3.1.2. | Data interchange with the modem | 28 |
| 7.3.1.3. | Modem management | 28 |

| | | |
|---|---|-----------------------------|
|  | GLOBAL STANDARD | Page 4 of 51 |
| | Remote Terminal Unit for secondary substations (UP) | GSTR001/1 Rev. 01 |

| | | |
|-------------|--|-----------|
| 8 | TESTING AND INSPECTION..... | 29 |
| 8.1 | Overview of the tests required for the RTU and its components | 29 |
| 8.2 | Type tests..... | 30 |
| 8.2.1 | Visual inspection..... | 30 |
| 8.2.2 | Tests of insulation and dielectric strength | 30 |
| 8.2.3 | Check of all of the functionalities | 30 |
| 8.2.3.1 | UE..... | 31 |
| 8.2.3.2 | PSBC..... | 31 |
| 8.2.4 | Stability check (PSBC only) | 31 |
| 8.2.5 | Electromagnetic interference immunity test | 31 |
| 8.2.5.1 | UE..... | 32 |
| 8.2.5.2 | PSBC..... | 32 |
| 8.2.6 | Thermal behavior test (PSBC only)..... | 33 |
| 8.2.7 | Climatic Tests | 33 |
| 8.2.8 | Mechanical tests | 34 |
| 8.3 | Acceptance tests | 34 |
| 8.3.1 | Preliminary checks..... | 34 |
| 8.3.2 | Functional check..... | 35 |
| 8.3.3 | Automatic Testing System (SCA)..... | 35 |
| 9 | SUPPLY REQUIREMENTS..... | 35 |
| 9.1 | Voltage selector switch in the PSBC | 35 |
| 9.2 | TCA documents and Manuals | 36 |
| 9.2.1 | TCA documents | 36 |
| 9.2.2 | Manuals | 36 |
| 9.2.3 | Safety warnings on Plate | 36 |
| 10 | AMBIENT OPERATING CONDITIONS..... | 36 |
| 11 | ELECTROMAGNETIC COMPATIBILITY..... | 36 |
| 11.1 | Immunity requirements | 36 |
| 11.2 | Emission limits | 36 |
| 12 | SAFETY REQUIREMENTS | 37 |
| 13 | SOFTWARE..... | 37 |
| 13.1 | Remote connection with the Center..... | 37 |
| 13.2 | Remote programming and configuration | 37 |
| 13.3 | Local programming and configuration | 37 |
| 14 | GENERAL PRESCRIPTIONS | 39 |
| 14.1 | Reliability..... | 39 |
| 14.1.1 | Normative references..... | 39 |
| 14.1.2 | Formulation of the reliability requirements | 39 |
| 14.1.3 | Verification tests of compliance with the declared failure rates..... | 39 |
| 14.2 | Project technical documentation | 39 |
| 14.3 | Spare parts..... | 39 |
| 14.4 | Equipment documentation | 40 |
| 15 | APPENDIX..... | 41 |

| | | |
|---|---|-----------------------------|
|  | GLOBAL STANDARD | Page 5 of 51 |
| | Remote Terminal Unit for secondary substations (UP) | GSTR001/1 Rev. 01 |

1 ACRONYMS

| | | |
|---|--------------|---|
| < | DCE | Data Circuit-terminating Equipment |
| < | DCS | Digital Cellular Service |
| < | DTE | Data Terminal Equipment |
| < | DFPI | Directional Fault Passage Indicator |
| < | FPI | Fault Passage Indicator |
| < | SD | Switch Disconnecter |
| < | SG | Switchgear |
| < | PSBC | Power supply/ battery charger of the RTU |
| < | PSTN | Public Switched Telephone Network |
| < | RGDAT | Enel standardized Directional fault passage and voltage loss indicator |
| < | RGDM | Advanced Fault Passage indicator with measuring acquisition |
| < | BVI | mains failure, Busbar Voltage Indicator |
| < | RC | Remote Control |
| < | RTU | Remote Terminal Unit |
| < | TM | Tele-Metering/Tele-Measurement |
| < | RS | Remote Signaling |
| < | TCA | Technical Conformity Assessment |
| < | TR | Transformer |
| < | UE | Processing Unit Device of the RTU |
| < | UP | Enel standardized Remote Terminal Unit for telecontrol and supervision of Medium Voltage distribution network |

| | | |
|---|---|-----------------------------|
|  | GLOBAL STANDARD | Page 6 of 51 |
| | Remote Terminal Unit for secondary substations (UP) | GSTR001/1 Rev. 01 |

2 APPLICABLE LAWS, REFERENCE STANDARDS AND ENEL STANDARDS

2.1 Applicable Laws and Standards

| | |
|---|--|
| IEC 60068-2-1:2007 | Environmental testing - Part 2-1: Tests - Test A: Cold |
| IEC 60068-2-14:2009 | Environmental testing - Part 2-14: Tests - Test N: Change of temperature |
| IEC 60068-2-2:2007 | Environmental testing - Part 2-2: Tests - Test B: Dry heat |
| IEC 60068-2-6:2007 | Environmental testing - Part 2-6: Tests - Test Fc: Vibration (sinusoidal) |
| IEC 60068-2-64:2008 | Environmental testing - Part 2-64: Tests - Test Fh: Vibration, broadband random and guidance |
| IEC 60068-2-78:2012 | Environmental testing - Part 2-78: Tests - Test Cab: Damp heat, steady state |
| IEC 60255-27:2013 | Measuring relays and protection equipment - Part 27: Product safety requirements |
| IEC 61000-4-12:2006 | Electromagnetic compatibility (EMC) - Part 4-12: Testing and measurement techniques - Ring wave immunity test |
| IEC 61000-4-16:1998 +AMD1:2001 CSV Consolidated version | Electromagnetic compatibility (EMC) - Part 4-16: Testing and measurement techniques - Test for immunity to conducted, common mode disturbances in the frequency range 0 Hz to 150 kHz |
| IEC 61000-4-18:2006 | Electromagnetic compatibility (EMC) - Part 4-18: Testing and measurement techniques - Damped oscillatory wave immunity test |
| IEC 61000-4-2:2008 | Electromagnetic compatibility (EMC) - Part 4-2: Testing and measurement techniques - Electrostatic discharge immunity test |
| IEC 61000-4-29:2000 | Electromagnetic compatibility (EMC) - Part 4-29: Testing and measurement techniques - Voltage dips, short interruptions and voltage variations on d.c. input power port immunity tests |
| IEC 61000-4-3:2006 | Electromagnetic compatibility (EMC) - Part 4-3: Testing and measurement techniques - Radiated, radio-frequency, electromagnetic field immunity test |
| IEC 61000-4-3:2006/ISH1:2008 | Interpretation sheet 1 - Electromagnetic compatibility (EMC) - Part 4-3: Testing and measurement techniques - Radiated, radio-frequency, electromagnetic field immunity test |
| IEC 61000-4-4:2012 | Electromagnetic compatibility (EMC) - Part 4-4: Testing and measurement techniques - Electrical fast transient/burst immunity test |
| IEC 61000-4-5:2014 | Electromagnetic compatibility (EMC) - Part 4-5: Testing and measurement techniques - Surge immunity test |
| IEC 61000-4-6:2013 | Electromagnetic compatibility (EMC) - Part 4-6: Testing and measurement techniques - Immunity to conducted disturbances, induced by radio-frequency fields |
| IEC 61000-4-8:2009 | Electromagnetic compatibility (EMC) - Part 4-8: Testing and measurement techniques - Power frequency magnetic field immunity test |
| IEC 60870-5-101: 2003 | Telecontrol equipment and systems - Part 5-101: Transmission protocols - Companion standard for basic telecontrol tasks |
| IEC 60870-5-104: 2006 | Telecontrol equipment and systems - Part 5-104: Transmission protocols - Network access for IEC 60870-5-101 using standard transport profiles |
| IEC 60529: 1989 | Degrees of protection provided by enclosures (IP code) |
| CISPR 22: 2008 | Information technology equipment - Radio disturbance characteristics - Limits and methods of measurement (international standard); |
| CEI EN 55022: 2014-02 | Information technology equipment - Radio disturbance characteristics - Limits and methods of measurement (instead of CISPR 22 for CENELEC Countries). |

| | | |
|---|---|-----------------------------|
|  | GLOBAL STANDARD | Page 7 of 51 |
| | Remote Terminal Unit for secondary substations (UP) | GSTR001/1 Rev. 01 |

IEC 61000-6-4: 2006-07 Electro-magnetic compatibility (EMC) - Part 6-4: Generic standards - Emission standard for industrial environments;

2.2 Enel Global Standards quoted in the document

| | |
|-----------|---|
| GSTR001/1 | Remote Terminal Unit for secondary substations (UP) |
| GSTR001/2 | UP - Box for indoor installations |
| GSTR001/3 | UP - Box for Outdoor installations |
| GSCG002 | Technical Conformity Assessment |
| GSCB001 | 12V Accumulators for remote control secondary substations |
| GSTP001 | RGDAT-A70 |

| | | |
|---|---|-----------------------------|
|  | GLOBAL STANDARD | Page 8 of 51 |
| | Remote Terminal Unit for secondary substations (UP) | GSTR001/1 Rev. 01 |

3 INTRODUCTION

Enel standardized MV remote control solution include a Remote Terminal Unit (RTU) and, optionally, as many fault detectors as the Line Out switches.

The components and elements of a MV/LV substation that can be remote controlled include MV and LV switch-disconnectors and circuit breakers. The Global Standard GSTR001 describe the standardized Remote Terminal Unit (RTU), also called UP, which can be used to remote control MV/LV substations, or to remote control pole mounted motorized switches. The UP is also the devices responsible to execute the self-healing distributed automation, when coupled with standardized fault detectors.

The central Remote Control System (Center, in the remainder) of the medium voltage distribution network is composed of:

- < a Central Unit;
- < a Front-end for communication with peripheral devices;
- < Working Stations;
- < etc.

The central unit is intended to perform the following functions:

- < validation and transmission of the commands given by the operator to the Remote Terminal Units (RTU);
- < acquisition, processing, and storage of data coming from the RTUs;
- < selection of the faulty branches;
- < configuration and remote diagnostics of the RTUs;
- < Synchronization of the clocks of the RTUs.

This document describes the functions of the RTU devoted to medium voltage distribution network, and provides, nonetheless, the construction requirements for the provision.

The Center is capable to use all of the communication systems available on the market (public switched telephone networks, mobile networks, etc.), or those which can be implemented *ad hoc* (dedicated radio networks), which ensure messages transit times compatible with the System requirements.

The RTUs are expected to carry out the following functions:

- < To communicate with the central system and ensure the forwarding to the field device of the remote controls received by the Center. A field device can be:
 - o Medium Voltage Switch Disconnectors (SD), located in Secondary Substations or pole mounted
 - o Medium Voltage Circuit-Breakers located in Secondary Substations or (SSCB) or pole mounted
 - o Reclosers
 - o Low Voltage motor-driven Circuit Breakers (LVCB) in the secondary substations (switchgears in their general acceptance);
- < To detect the status of the switchgears and the diagnostics of each RTU, and make them available to the Center;
- < To detect the fault signal from the fault passage indicators or protections (RGDAT/RGDM) that are installed in correspondence of the switches to be monitored, and subsequently store them with the date/time of occurrence, in order to make them available to the Central Unit;
- < To implement automatic procedures for the selection of the faulty branches;
- < To record field measurements (indoor temperature of the substation, currents, etc.), and make them available to the Center.

The RTUs can also be used as a part of MV/MV switching substations, where they remotely control the circuit breakers, and record the signals and measurements from the related protection and control panels.

| | | |
|---|---|-----------------------------|
|  | GLOBAL STANDARD | Page 9 of 51 |
| | Remote Terminal Unit for secondary substations (UP) | GSTR001/1 Rev. 01 |

4 LIST OF COMPONENTS, PRODUCT FAMILY OR SOLUTIONS

4.1 Components of the Remote terminal Unit for Secondary substation in the configurations available

The UP is available in different configurations, applicable to indoor and outdoor installations.

It consists of:

- < a rack mounted processing unit device, namely UE
- < a rack mounted power supply/battery charger, namely PSBC
- < the cabinet, that can be suitable for indoor or outdoor installation

The UE and the PSBC are both suitable for installation to either indoor or outdoor cabinets and their characteristics are described in this specification.

The containers can have different shapes according to their applications. Their characteristics are described in the following Global Standards:

- < UP Cabinet for Indoor installations: **GSTR001/2**
- < UP Cabinet for Outdoor installations: **GSTR001/3**

4.2 Enel Product family codes of the components

| Global Product Family Code | Device Code | Description | Reference Global Standard | Included in the Global Product family code |
|----------------------------|-------------|---|---------------------------|--|
| 519530 | | Complete UP kit for Indoor application, mounted in the Wall-mounted indoor cabinet container equipped with UE8 | GSTR001/1 GSTR001/2 | PSBC UE8 WM-UP8 |
| 519532 | | Complete UP kit for Indoor application, mounted in the Wall-mounted indoor cabinet container, equipped with UE16 (Processing Unit Device capable to telecontrol for 16 switchgears) | GSTR001/1 GSTR001/2 | PSBC UE16 WM-UP8 |
| 519503 | | Complete UP kit for Outdoor application, mounted in the Outdoor cabinet container | GSTR001/1 GSTR001/3 | PSBC UE8 OS-UP |
| 519541 | PSBC | Power supply and battery charger | GSTR001/1 | |
| 519542 | UE8 | Processing Unit Device capable to telecontrol for 8 switchgears | GSTR001/1 | |
| 519543 | UE16 | Processing Unit Device capable to telecontrol for 16 switchgears | GSTR001/1 | |
| | CM-UP | Ceiling-mounted indoor cabinet container for Remote Terminal Unit | GSTR001/2 | |
| 519544 | WM-UP | Wall-mounted indoor cabinet container for indoor Remote Terminal Unit | GSTR001/2 | |
| 519545 | OS-UP | Outdoor cabinet container for pole-mounted Remote Terminal Unit - standard version | GSTR001/3 | |
| 519546 | OXL-UP | Outdoor cabinet container for pole-mounted Remote Terminal Unit - Extra-large version | GSTR001/3 | |
| 519547 | | Spare part: connection cable to the switch | | |
| 519548 | | Spare part: connection cable to the RGDAT | | |

| | | |
|---|---|-----------------------------|
|  | GLOBAL STANDARD | Page 10 of 51 |
| | Remote Terminal Unit for secondary substations (UP) | GSTR001/1 Rev. 01 |

4.3 Enel Product family codes of the components adopted in each Company within Enel Group

| Description | Global Product Family Code | Argentina | Brazil | Chile | Colombia | Italy | Peru | Romania | Spain |
|---|----------------------------|------------------------|---------|---------|----------|--------|---------|---------|--------|
| Complete UP kit for Indoor application, mounted in the Wall-mounted indoor cabinet container | 519530 | 0131-0403 ¹ | | 6808327 | 6810358 | 519530 | 6810358 | 519530 | 510255 |
| Complete UP kit for Outdoor application, mounted in the Outdoor cabinet container | 519503 | 0131-0404 | 6810357 | 6808328 | 6810357 | 519503 | 6810357 | 519503 | 510258 |
| Complete UP kit for Indoor application, mounted in the Ceiling-mounted indoor cabinet container | | | | | | | | | 510257 |

4.4 List of components, product family and solutions to which the Global Standard applies

The RTU consists of a rack mounted processing unit device, namely UE, and a rack mounted power supply/battery charger, namely PSBC, suitable for either indoor or outdoor cabinet containers, described in the **GSTR001/2** and **GSTR001/3** specifications, respectively.

The RTU is composed of two functional blocks, both housed in a cabinet container, as shown in Table 1 - Functional blocks of the RTU:

¹ The Complete UP kit for Indoor application in Argentina corresponding to this product family code differs to the Global solution in the cabinet, as described in the Annex I to GSTR001/2

| Device | Product family code | Description |
|-------------|---------------------|---|
| PSBC | 519541 | Power supply and battery charger: It is the power supply/ battery charger of the RTU, switchgears and auxiliary devices (modem, router, etc.) |
| UE8 | 519542 | Processing Unit Device capable to telecontrol for 8 switchgears |
| UE16 | 519543 | Processing Unit Device capable to telecontrol for 16 switchgears |

Table 1 - Functional blocks of the RTU

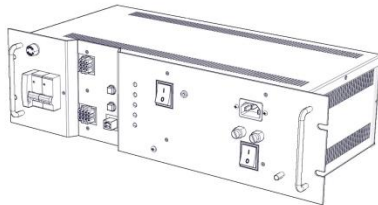

Figure 1 – PSBC

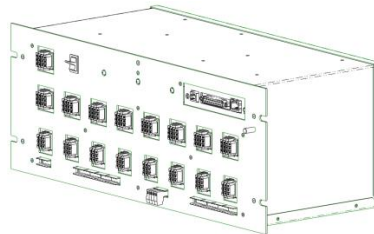

Figure 2 – UE8

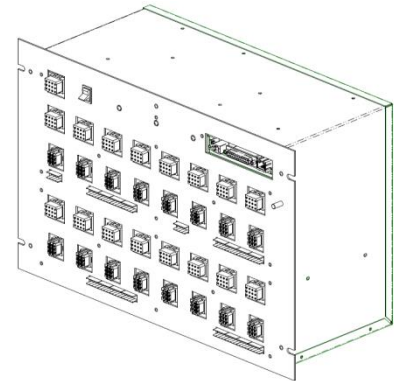

Figure 3 – UE16

The UE and the PSBC devices are equipped with the accessories provided in Table 2:

| Accessories | Product family code | Device | Description | Included in the supply |
|---------------------------------------|---------------------|----------|---|------------------------|
| Cable connecting UE to PSBC | | UE8/UE16 | The cable is composed of 11 conductors, with section 1,5mm ² , terminating with two 12 pin locking connectors (see Figure 9). | Yes |
| RS232 cable for DCE connection | | UE8/UE16 | It is a DB9 Female/DB25 Male Modem Cable of length equal to 1.5m. | Yes |
| Mains three pole plug | | PSBC | It is a three-pole plug (type IEC C13 according to IEC 60320 standard) for the termination of the cable (not included) of the AC power supply | Yes |

Table 2 - Accessories of the UE and PSBC devices

5 TECHNICAL CHARACTERISTICS OF THE UE

5.1 Construction characteristics

The UE functional blocks must be designed as a chassis frame rack. The size of the chassis must be the following:

“ a height equal to 4U, as to the UE8 version;

| | | |
|---|---|-----------------------------|
|  | GLOBAL STANDARD | Page 12 of 51 |
| | Remote Terminal Unit for secondary substations (UP) | GSTR001/1 Rev. 01 |

- “ a height equal to 7U, as to the UE16 version;
- “ a depth equal at most to 25 cm for both the UE8 and UE16 versions, according to the dimensions described in Figure 4.

The UE8 and UE16 devices are made of steel or an equivalent material in terms of electromagnetic compatibility and rigidity of the structure. They are supported only by the screws of the front panel. The UE must ensure at least an IP30 degree of protection (EN 60529).

Front panels must be provided with a 6MA grounding bolt.

5.2 UE Functions

The UE has to allow the execution of configurable actuation time commands, in order to remote control different types of existing switchgears (switch disconnectors, LV circuit breakers, reclosers, and MV circuit-breakers).

For each switchgear, the UE must record double permanent signals for its status (open and closed).

In the case of switched line\GSM channel communication between the UE and the central system:

- ◁ The UE must be capable to independently establish the connection with the Center (spontaneous calls), as a consequence of specific events previously configured or when analog measurements exceed preconfigured thresholds.
The Center must be capable to execute the spontaneous call by means of a remote command;
- ◁ The UE must manage a phone list consisting of three numbers to call in case of spontaneous call event.

Communication between the Center and the UE can also be permanent:

- ◁ on dedicated line, by using EC 60870-5-101 protocol;
- ◁ on IP network using IEC 60870-5-104 protocol and either the Ethernet port or the serial port (provided on the front).

The UE has to run the following monitoring functions related to the MV network operation:

- ◁ chronological recording of fault current flows;
- ◁ measurements execution;
- ◁ faulty branch selection;
- ◁ auxiliary functions.

5.2.1 Chronological recording of fault current flows

The UE has to chronologically record all the fault current passages due to short circuits (phase over currents) or ground faults (zero sequence currents), detected by the fault passage indicators (RGDM, RGDAT), installed on the feeder departures.

In order to discriminate the fault events that can occur even over a short time (three tenths of a second) due to rapid reclosing, the UE has to record fault current flows with a temporal precision of about one tenth of a second.

These events must be generated only during transition of signals from idle status to active ones.

Chronological recording of fault current flows must be made available to the Central Unit, to be used:

- ◁ in real time, when permanent faults occur, for the selection of the faulty branch;
- ◁ in deferred time, to facilitate maintenance operations.

| | | |
|---|---|-----------------------------|
|  | GLOBAL STANDARD | Page 13 of 51 |
| | Remote Terminal Unit for secondary substations (UP) | GSTR001/1 Rev. 01 |

5.2.2 Measurements

The UE is equipped with analogue inputs for the measurement of significant parameters of the secondary substation. A dedicated input for a PT100 sensing element must be provided in order to measure the ambient temperature.

5.2.3 Faulty branch selection

The UE must implement a series of local automatisms. According to the status of given inputs, these automatisms generate the opening and/or closing commands of the switchgears aimed at searching the faulty branch.

Upon the occurrence of well-defined events, or specific status transitions, the UE must be able to generate spontaneous calls toward the Center.

From the Center it has to be possible to individually disable each function related to spontaneous call and/or exclusion of the automatisms, by means of remote commands.

The comprehensive description of all the automatisms to be implemented in the UE is included in a specific confidential technical specification. The technical specification describing the Automatisms will be delivered in its complete version only after the contract is awarded.

During the tender, only an extract is provided, being sufficient for a technical/economic assessment.

5.2.4 Auxiliary functions

5.2.4.1. Communication

The Center has to be capable to communicate with the UE by means of all the following media:

- < Switched Telephone Network (PSTN);
- < 4-wire dedicated analog channels (4W Leased);
- < GSM and DCS 1800 mobile network;
- < IP networks;
- < Satellite network;
- < Radio network.

The device Hardware and software architecture must be flexible and easily allow the interchangeability among the above mentioned communication systems, as explained in the remainder.

5.2.4.2. Diagnostics

The UE must include diagnostic functions of control, management, and local and remote reporting of anomalies in the operation of its functional parts.

5.2.4.3. Date/time clock function

The UE must be equipped with an internal low drift and high resolution date/time clock.

All fault current detection or other system events must be stored in the internal buffer with a date/time stamp, according to a timing resolution of one tenth of a second.

5.2.5 Configuration and Programming

It has to be possible to fully configure and program the UE either:

- < locally, by means of a PC (not included in the supply), connected to the USB port
- < remotely, via the DCE or the Ethernet network.

| | | |
|---|---|-----------------------------|
|  | GLOBAL STANDARD | Page 14 of 51 |
| | Remote Terminal Unit for secondary substations (UP) | GSTR001/1 Rev. 01 |

The UE configuration, either locally or remotely, is described into Annex 1.

Annex 2 contains the overall list of the UE configuration parameters.

Annex 3 provides the list of the Information Object Addresses (IOAs), compliant with the IEC 60850-5-101/104 protocols, related to the signals, measurements, controls, statuses of the automatism stored into the UE database.

The addition or modification of any record in the UE database must be possible by updating the device application firmware and reconfiguring it from the Center (i.e. local reconfiguration must not be required).

All of the user application software provided must meet the following requirements:

- < Compatibility with OS Windows 7 and OS Windows 10 64 bit;

- <

A mobile application (ANDROID 4.2) must be also provided, useful to either configure the UE or update the firmware locally, by means of the UE USB port. In order to facilitate the user in the configuration via mobile, the application will be provided with a set of standard configurations.

All the interactions (configuration, visualization, firmware download and upload) between the software and the UE on the Ethernet port, must be performed encapsulated in secure protocol (latest version possible of SSH), and file transmission must be performed using SCP.

5.2.5.1. Configuration uploading

The changing of any parameter must be made starting from the configuration setting which is in the UE in that moment, in order to avoid the risk of operating on outdated data.

As a consequence, at the beginning of each connection with the UE, the existing configuration must be uploaded, before proceeding with any local or remote configuration of the RTU.

5.2.5.2. Downloading of the firmware

It must be possible to update locally the firmware of either the UE or the PSBC to the latest version (local downloading), through the same software used also for the configuration.

Nonetheless, it has also to be possible the remote download of the firmware for one or more UE (management of lists of devices). This operation may be executed either by the Center, by means of the same communication devices normally used for the remote control, or from a standard PC with a modem or LAN. For this purpose, a suitable software module must be provided, to be installed on a PC.

5.3 UE technical details

The UE is equipped with connectors and terminals, to interface with the controlled/monitored devices.

Two versions of the UE must be provided (UE8 and UE16), able to handle, respectively, 8 and 16 switchgears.

On the front, the UE8 version is equipped with:

- < 8 female 12-socket connectors and 8 female 9-socket connectors (Figure 4), corresponding to the floating connectors utilized respectively on the switchgears and the fault passage indicators;
- < 20 terminals for 10 Remote Signals (RSs):
 - o 8 spare RSs;
 - o 1 RS for substation door opening detection;
 - o 1 RS for the transformer switch opening detection;
- < 20 terminals for 9 Telemeasurements (TM):

| | | |
|---|---|-----------------------------|
|  | GLOBAL STANDARD | Page 15 of 51 |
| | Remote Terminal Unit for secondary substations (UP) | GSTR001/1 Rev. 01 |

- 1 Telemasurement of ambient temperature (Tamb- 4-wire PT100 sensing element);
- 8 spare TMs.

The UE16 version is equipped on the front with:

- ◁ 16 female 12-socket connectors and 16 female 9-socket connectors (Figure 4), corresponding to the floating connectors respectively utilized on the switchgears and the fault passage indicators;
- ◁ 36 terminals for 18 Remote Signals (RSs):
 - 16 spare RSs;
 - 1 RS for substation door opening detection ;
 - 1 RS for the transformer switch opening detection.
- ◁ 20 terminals for 17 Telemasurements (TM):
 - 1 Tele measuring of ambient temperature (Tamb- 4-wire PT100 sensing element);
 - 16 spare TMs.

The list of all of the signals, controls, telemasurements and digital outputs are provided in Table 8, Table 12 and Table 16 of the Appendix.

Terminals must clamp conductors with an equivalent section of 1.5 mm².

The digital outputs consist of an open collector PNP transistor, characterized by a maximum current equal 50mA. The relative internal variable ISV (see GSTR001/1/A1 for details): ISV=1, high digital output; ISV=0, low digital output. In the case of RGDM or RGDAT, the digital output is utilized to control the inversion of the direction of the fault detection.

The UE is further equipped with:

- ◁ A Local/Remote-control rotary switch to enable devices installed in the secondary substation to local electrical control (in the L position) or to remote control (in the T position). It provides local indication and remote alarm to be sent to the Center. The selector also control the switch of the auxiliary supply, +A, from the + L to the +T position (see Figure 6).
- ◁ 3 diagnostic LED;
- ◁ a reset button of the apparatus;
- ◁ a 2.0 USB interface for local programming;
- ◁ a DB25 RS232 connector for the DCE connection;
- ◁ a RJ45 Ethernet port; the default configuration must be:
 - IP Address 192.168.1.2
 - Subnet Mask 255.255.255.0
 - Default GW 192.168.1.1
- ◁ a male 12-socket connector for connection of the supply circuits (signal and supply).

The connection between the UE and the PSBC is performed via a multiple cable terminated at both ends with a floating 12-socket connector (of the same type as those used for the connection of the switchgears). The section of each cable must be equal to 1,5mm², whereas the pinout is described in Table 18.

5.3.1 Connectors

The coupling of the fixed and floating parts of each connector must be facilitated by polarization rails, and secured by elastic locking devices.

| | | |
|---|---|-----------------------------|
|  | GLOBAL STANDARD | Page 16 of 51 |
| | Remote Terminal Unit for secondary substations (UP) | GSTR001/1 Rev. 01 |

The connectors will be equipped only with the necessary contacts needed to perform the functions specified in the wiring diagrams.

The contacts used must have the characteristics shown below, while also considering the surface treatment and finishing:

| | | |
|---|---|---------------------|
| < | withstand voltage: | 2kV _{AC} - |
| < | rated capacity | 13A |
| < | voltage drop on a male-female terminal pair, traversed by a 5 A current | U 50mV |
| < | insertion-extraction force: | 0,40 ±10N/contact |

The arrangement of connectors on the front of the UE (the provision shown in Figure 4 is only indicative) must allow the easy insertion and extraction of the connectors themselves.

If the connectors plate is directly made by the printed circuit board, suitable reinforcements must be provided in order to allow the insertion and the extraction of the connectors without excessive bending of the plate itself.

5.3.2 Input terminals

The input terminals must clamp conductors with a diameter equal to 1.5 mm².

5.3.3 Power supply

The UE is supplied by a 24V -15%, + 20% PSBC, which is described in **Chapter 6**.

The UE must be immunized against transient reductions of the supply voltage from 24V to 12V, for a 100ms time interval.

The UE must provide with a protection against the reverse polarity of the power supply wires.

The UE delivers the 24V_{DC} power supply (by means of the pins +M and -M of the 12 socket connectors, see Figure 7) to all of the switchgears in connection with it. The internal conductors of the UE (either cables or patterns of the printed circuit boards), related to the power supply of the motors, must be of equivalent section not less than 2mm².

5.3.4 Remote controls

Each command must be sent to the field by means of actuator relays with voltage free contacts.

The equivalent section and isolation of the conductive patterns and wires must be suitable to withstand a continuous current equal to 5A and a voltage equal to 110V; the relays must have the following characteristics:

| | | |
|---|---|--|
| < | Rated current of the contacts: | 5 A. |
| < | Voltage Surge between coils and contacts: | 3 kV. |
| < | Limiting breaking capacity: | 0.5A with time constant equal to 40ms. |
| < | Electrical endurance: | 1x10 ⁵ operations at the rated breaking capacity. |

The ON time (output pulse length) of each output relay must be programmable at least between 0.1 and 2 seconds, in steps of 0.1 s.

| | | |
|---|---|-----------------------------|
|  | GLOBAL STANDARD | Page 17 of 51 |
| | Remote Terminal Unit for secondary substations (UP) | GSTR001/1 Rev. 01 |

The local/remote-control rotary switch, located on the front panel of the UE, must disable the actuator relays.

In the execution of an output command, a double safety check must be done.

In particular, the execution of a command must include three steps:

1. 1/N verification;
2. selection of the channel of the switchgear;
3. execution of the command.

To each step, the verification that it has been performed successfully has to follow. A single fault must not cause, in any case, the execution of unwanted commands.

The impedance value to be verified during the 1/N preparation step must be in the range of 5-5000 . Outside of this range, the step is considered failed and the related alarm is generated.

The execution of a control (double safety procedure included) must be performed within 30ms.

5.3.5 Remote signals

UE8 and UE16 versions must be provided respectively with 49 and 89 digital input signals.

It has to be possible to configure each digital input of the UE, as either a simple or double signal, i.e. associated to the status of an additional digital input (as an example, the signaling of the open/closed position of the switchgears).

In addition, it has to be possible to configure:

- < the idle status of the signal;
- < the generation of an event associated to a signal;
- < the type of event to be generated (status, status change, status change with delay, status change with delay and status change with delay and status change with delay);
- < the generation of a spontaneous call to the Center;

It has to be also possible the configuration and tuning of the signals from the Center or using the remote configurator software.

Upon the occurrence of an alarm condition on one of these digital inputs, the UE sends spontaneously the information to the Center. To do so in case of GSM connection, in particular, the UE calls one of the three configured telephone numbers of the control Center.

Once the connection with the Center is established, the UE transfers a message, containing the status change that caused the spontaneous call.

If the above connection is not established correctly, the transmission attempts must be repeated until the UE receives confirmation of the regular reception of the message. The amount of attempts, and the time lapse between two consecutive attempts must be programmed remotely.

This is needed to prevent the transmission channels to be continuously busy, which would be incompatible with the proper operation of the network.

The spontaneous calls can be disabled via a remote control sent from the Center.

Each digital input of the UE will be provided with a debounce filter, which must be singularly programmable within the range of 10÷5000ms, with a step of 10ms.

The scan rate of all UE inputs must be equal to 10ms, in the worst case.

The events generated by the input signals (particularly those which are related to fault currents) must be stored in a circular buffer with a storage capacity of 200 records at least. The data to be stored for each event generation pertain to the status of the digital input which generated the event, with associated date . time stamp of generation (according to an accuracy to the tenth of a second).

| | | |
|---|---|-----------------------------|
|  | GLOBAL STANDARD | Page 18 of 51 |
| | Remote Terminal Unit for secondary substations (UP) | GSTR001/1 Rev. 01 |

5.3.6 Measurements

The analogue inputs (9 or 17 TM, depending upon the UE version) must be balanced-type, differential, insulated from any supply polarity and allow the reset of the measurement offset for each individual channel.

The UE acquires current signals, with the possibility to set two different scales:

...5 mA DC

4 ÷ 20mA DC.

The analog measurement related to the temperature probe differs from the other analog inputs as the signal transducer is integrated in the UE itself. Furthermore, and only for this particular analog channel, it must be used a fixed codification, using the following linear characteristic:

| Temperature | Codified value |
|-------------|----------------|
| -30°C | 0 (zero) |
| +100°C | 32767 |

Each analog input must be protected against overload from values which exceed 20% of the maximum value.

The resolution of the analog/digital conversion must be ± 12 bit (over the entire input range); the accuracy of the entire chain of conversion must be $\pm 1\%$.

The analog inputs must be sampled according to the following frequencies:

- < at least once a second when there is a telemeasurement session on going;
- < at least once per minute in the case of automatic monitoring (normal working condition with no telemeasurement session activated).

It must be possible the association of an alarm condition to one or more inputs when a minimum and/or maximum threshold limit has been exceeded. The exceeding of one of these limits must produce an event and manage it similarly to what happens for the digital inputs.

The telemeasurement session is activated in order to update the measurements displayed to the operator by the Center.

In the case of automatic monitoring, incoming data will be managed by the RTU, which will process and store the average values at intervals of 10 minutes (according to CEI EN 50160, §2.2). The stored average values will be transmitted to the Center upon specific interrogation.

Local memory areas must be included in the UE, so as to store the average values for a period of at least 2 weeks.

The measurement trends, downloaded by the Center via file transfer, must be organized in the format described in the GSTR001/1/A3.

5.3.7 Data buffering mode

The events generated by the UE have to be stored in different buffers, each related to a type of signal (SP Single Point, DP Double Point, et cetera), according to a chronological order. Doing so, during the phase of data transfer to the Center, the response packets to the polling will contain the maximum amount of data (except for the last packet, for each type, whose size can be partial

| | | |
|---|---|-----------------------------|
|  | GLOBAL STANDARD | Page 19 of 51 |
| | Remote Terminal Unit for secondary substations (UP) | GSTR001/1 Rev. 01 |

The advantage of this data buffering mode is the minimization of the number of packets (and therefore of transmission time) required to transfer information to the Center. That applies especially when many heterogeneous event types are generated, which is the typical case of the automation cycles.

The correct chronological reconstruction of the events is the responsibility of the Center, utilizing the time-stamps associated with such events.

During the General Interrogation phase, the events are always sent by type, although, in this case, without the time-stamp.

5.3.8 Diagnostics

Communication and transmission

For the diagnosis of communication it is necessary to refer to the instructions listed in the standards CEI EN60870-5-101 and EN60870-5-104.

Hardware malfunctions

In case of hardware malfunctions detected by online diagnostics of the UE, appropriate error codes must be issued.

Local optical signaling

The UE must be provided with leds, which are placed on the front of the panel, showing:

- < the presence of a 24 V_{DC} power supply;
- < RTU warnings/DCE communication status;
- ← RTU failure.

The UE must be provided with a reset button, as well.

Watch-dog circuit

The UE must be equipped with a watch-dog circuit for the automatic reset, in case the program execution is blocked.

5.3.9 Features of the date-time clock

The clock-calendar must have a resolution of one tenth of a second and a maximum drift of less than 5 ppm, within a temperature range of -10 ÷ 55 °C, sufficient to ensure the right execution of all of the provided functions.

The synchronization must be carried out with a proper message, which is periodically sent by the Center; after this synchronization, the maximum residual misalignment must be less than 100ms.

In the reply message to the synchronization, the UE must return the couple date/time it had before the resynchronization, according to the CP56 Time2a format described in the specification CEI EN60870-5.

Upon UE startup, the clock and calendar must be initialized as follows:

- < time 00:00:00,
- < date 01/01/2000.

6 TECHNICAL CHARACTERISTICS OF THE PSBC

The PSBC charges the batteries which supply power to the components installed in the secondary substations or in the pole mounted installation:

- < switchgears: motor driven switch disconnectors (SD), secondary substation/ pole mounted circuit-breakers , LV circuit breakers, reclosers;
- < directional fault passage indicators (RGDM or RGDAT);
- < UE;
- < DCE.

| | | |
|---|---|-----------------------------|
|  | GLOBAL STANDARD | Page 20 of 51 |
| | Remote Terminal Unit for secondary substations (UP) | GSTR001/1 Rev. 01 |

6.1 PSBC construction characteristics

The PSBC functional block must be realized as a box panel frame rack.

The panel size must be:

- < height equal to 3U;
- < depth equal to 25 cm at most, in accordance to the dimensions reported in Figure 4.

The PSBC panel is made of steel, or an equivalent material in terms of electromagnetic compatibility and rigidity of the structure. It is supported only by the screws of the front panel. It must ensure a degree of protection IP30 (EN 60529).

The PSBC is also provided on the front with two handles, in order to facilitate the operations of assembly and disassembly from the cabinet container.

Side panels are provided with ventilation holes (Figure 4).

Front panel must be provided with a 6MA grounding bolt.

The PSBC must be provided on the front of a USB 2.0 port for the connection to a PC.

6.2 PSBC electrical characteristics

The power supply, whose circuit diagram is shown in Figure 5, must include:

1. a rectifier section
2. a battery charger section
3. an electronic card with functions of self-diagnosing and control of the power supply, as well as protection, switching, adjustment and signaling devices.

Under normal operating conditions, the PSBC will contribute to the supply of the UE and the auxiliary devices mentioned before (loads), and will keep the batteries charged.

In case of a loss or a temporary fault of the mains, the PSBC must provide the DC power supply, by means of the battery, until the system is restored to normal operating condition, preserving the loads from any power interruption.

The PSBC must be made up of:

1. a power isolation transformer, rated at 50 Hz/60 Hz (with a grounded electrostatic shield interposed between the primary and secondary windings),
2. a rectifier bridge with silicon diodes,
3. a decoupling diode from the battery.

In case of pole mounted installations, the input voltage of PSBC can be provided by a transformer having the following characteristics:

- < Primary winding voltage: it depends on the MV nominal voltage of the involved network/country;
- < Secondary winding voltage: 230 V_{AC} or 100 V_{AC};
- < Nominal power: 250 VA.
- < Insulation voltage: 10 kV industrial frequency.

The choice between a 100V and 230V_{AC} power supply must be made by means of a suitable selection switch, positioned at the rear of the PSBC. As default position, the power supply must be provided with the selector switch set to 230V_{AC}. (see also **Chapter 9 Supply Requirements**)

| | | |
|---|---|-----------------------------|
|  | GLOBAL STANDARD | Page 21 of 51 |
| | Remote Terminal Unit for secondary substations (UP) | GSTR001/1 Rev. 01 |

The characteristics of the power supply must be the following:

| | |
|---|---|
| - Rated Voltage: | 100/230V _{AC} . |
| - Voltage Range: | -10% ÷ 20% of the rated voltage |
| - Rated frequency: | 50/60Hz Compatibility with a 60Hz operation must be guaranteed. |
| - Rated output voltage: | 24V _{DC} |
| - Output voltage adjustment range: | 23 ÷ 28V _{DC} |
| - Maximum output current (fixed): | 5A .. 5% (for varying values of the input voltage within the prescribed range) |
| - Efficiency: | ‡ 75% ± 3% (at the maximum output current equal to 5 A and at the rated voltage equal to 24 V _{DC}) |
| - Steady state stability (for simultaneous variations of the mains voltage from 90% to 120% of the rated voltage, under any loading condition from 0% to 100%): | ±1% |
| - Dynamic state stability (for load steps of ¼, ½, ¾ of the maximum output current): | ±5% |
| - Ripple at the maximum output current | ±2% |

The output voltage of the PSBC must be set (with regulating step of ±0,02V) equal to the rated voltage indicated by the battery manufacturer (normally 27.24V, equal to 2.27 V/cell, at 20 °C).

The PSBC must charge the absorbed electrolyte batteries. In this case, the value of the charging voltage must change automatically as a function of the value of the temperature assumed by the battery.

For this purpose, the PSBC must be equipped with a temperature probe (supplied with connection cable length equal to 0.5m without terminals interposition), to be placed near the batteries.

The voltage output must be modified according to this function:

$$V_{ch}(T) = (27.96 - 0,036T) \pm 1\%$$

Where, T is the measured temperature, in °C and V_{ch} is the charging voltage.

The ON and OFF switching of the rectifier with neither load nor battery must not lead to over voltages at the output exceeding 5% of the rated value.

All control and verification of the set values must be available via software.

| | | |
|---|---|-----------------------------|
|  | GLOBAL STANDARD | Page 22 of 51 |
| | Remote Terminal Unit for secondary substations (UP) | GSTR001/1 Rev. 01 |

6.3 Control of the mains, power supply and battery voltages

Mains power, battery voltage and all of the PSBC functionalities must be continuously monitored by means of electronic circuits, as described in the diagram of Figure 5.

These circuits must carry out the following functions:

- 1) Switch off the local signaling of "MAINS" and generate a remote alarm "Mains failure/BVI" when the supply voltage at 230 V_{AC} (V_n) takes a value $\leq 20\%V_n \pm 10\%$ for a time interval $\geq 200ms \pm 10\%$. The previous alarm must be reset when the mains voltage reach a value $\geq 80\%V_n \pm 10\%$ for a time interval $\geq 250ms \pm 10\%$. The mains voltage monitoring must be upstream of the fuses.
- 2) Generate an alarm, with local and remote signaling of "LOW V_{DC}", when the battery voltage value is $\leq 23.5V \pm 1\%$, for a time interval of 30s $\pm 10\%$. The alarm is reset when the voltage assumes a value $\geq 24.5V \pm 1\%$. The threshold, as well as the duration of the debounce filter must be programmable, according to a range of 20÷30V_{DC} with step of 0.1V, and a range of 0÷60s with step 1s, respectively.
- 3) Switch off the normally-on local signaling of "V_{DC} ON" when the measured voltage has a value $\leq 21.6V \pm 1\%$ for a time interval $\geq 30s \pm 10\%$, and disconnect all of the auxiliary circuits (by de-energizing the A relay - Figure 5). The maximum current consumption of the system, after the switch-off of the auxiliary circuits, must be $\leq 50mA$. The restoration process of the load is starting automatically when the battery voltage assumes a value of 22.8V $\pm 1\%$ and the led "V_{DC} ON" is on.
- 4) Generate an alarm, with a local signal of "MAXIMUM V_{DC}" and a remote signal of "RECTIFIER FAILURE", and disconnect (by setting the bistable B relay) from the mains supply when the output voltage on the rectifier (measured upstream of the decoupling diode) assumes a value $\geq 29.1V \pm 10\%$ for a time interval $\geq 5s \pm 10\%$. The restoration of the mains supply must occur automatically, after 30 min $\pm 10\%$, while the restoration of the remote signal of "RECTIFIER FAILURE" must take place after 10 min $\pm 10\%$ from the eventual successful restoration. The restoration must be also possible by means of the "RESET" button. Local signaling of "MAXIMUM V_{DC}" must be restorable manually via "RESET" button only. V_{threshold} must be programmable, according to a range of 25÷35V_{DC} with step of 0.1V, and a range of 0÷60s with step 1s, respectively.
- 5) Generate a remote alarm of "RECTIFIER FAILURE" at the intervention of the 230 V_{AC} power supply fuses.
- 6) Generate a local alarm of "BATTERY FAILURE" and enable the remote signal of "Battery Fail", when the efficiency test of the battery fails. This alarm must be reset manually, using the reset button.

6.3.1 Test of the battery efficiency

A circuit must provide the verification of the battery efficiency; it must be activated by a configurable timer inside the power supply, and a "TEST" button on the front of the power supply. During the test run, the "BATTERY FAILURE" LED, located on the front panel, must blink.

The test must reduce the power supply output voltage to an appropriate level, and perform a discharge of the battery by supplying a resistive load of 13.5 ohms, for a maximum time interval of 15 min $\pm 10\%$.

The test must not cause any alarm issue (LOW V_{DC}, RECTIFIER FAILURE, etc.) if it is successful.

The threshold voltage (V_{threshold}) used to discriminate the outcome of the test must be programmable via software from 22.45 to 25 V_{DC} (according to a step equal to 0.05), and It must have a default value equal to 23.75V.

The test must run periodically (with a programmable frequency, set by default to "weekly") and must be excluded via software.

6.3.2 Specification of the DCE power supply section

The PSBC has to be capable to supply the DCE with a 12V DC ..10% direct current power output, isolated from the UE power supply (24V with grounded positive terminal) through the interposition of a DC/DC converter with a supply capacity of at least 8W with no interruption.

The DCE power supply section must comply with the following characteristics (which are typical of the GSM type DCE used by ENEL):

| Condition | | Value | Effect |
|-----------------|-------------|---------------------|---------------------------------------|
| Minimum voltage | 900/1800MHz | < 8V _{DC} | Operation is not guaranteed |
| Maximum voltage | 900/1800MHz | > 36V _{DC} | Overtoltage protections are triggered |

Table 3 - Absolute Limits

A fuse positioned on the supply cable guarantees the permanent overvoltage protection.

| Parameters | GSM 900 | | | DCS 1800 | | | Unit |
|----------------|---------|------|------|----------|------|------|-----------------|
| | Min. | Typ. | Max | Min. | Typ. | Max. | |
| Supply voltage | 9,6 | 12 | 28.8 | 9,6 | 12 | 28.8 | V _{DC} |
| Peak current | | | 2,5 | | | 1 | A |

Table 4 - Operating Limits

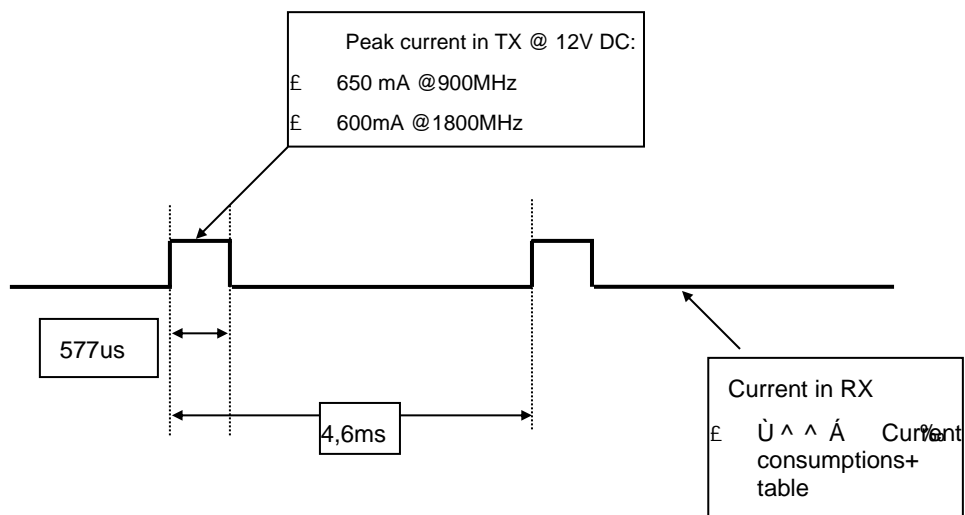

Peak current diagram

In case of 2G/3G modules the constraints are the followings:

- < Voltage range: 9.6 to 30 VDC; max ripple of ..10%;
- < Maximum power absorbed in all conditions: ≤ 8 W, excluding instantaneous peaks;
- < Instantaneous peak absorptions: within the limits specified by the following Table 5.

| Supply voltage | Average current in RX | Average current in TX (GSM900) | Average current in TX (DCS1800) |
|----------------|-----------------------|--------------------------------|---------------------------------|
| 9,6V | 80mA | 310mA | 230mA |
| 12V | 65mA | 250mA | 180mA |
| 19,2V | 40mA | 150mA | 110mA |
| 24V | 35mA | 120mA | 90mA |
| 28.8V | 30mA | 100mA | 75mA |

Table 5 - Current Consumption

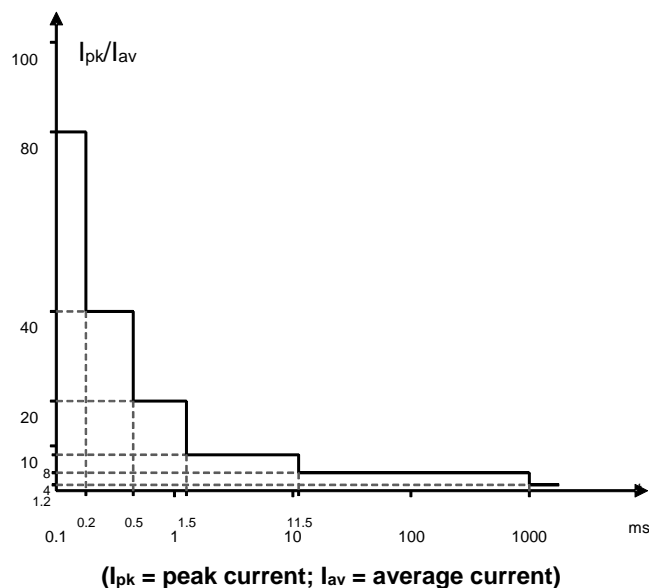

DCE module can be also supplied directly by 24V_{DC}; in this case DCE must be compliant with grounded positive pole of battery section.

6.3.3 Configuration, signaling and protection devices.

On the front of the panel, as shown in Figure 4 the following items are mandatory:

- ◁ n°5 LEDs for the local signaling of:
 - MAINS, green led (relay 27);
 - V_{DC} ON, green led (relay A);
 - LOW V_{DC}, red led (relay 80);
 - MAXIMUM V_{DC}, red led (relay 45);
 - BATTERY FAILURE, red led;
- ◁ a button (RESET) to restore the operation of the PSBC;
- ◁ a BATTERY TEST button to activate the test;
- ◁ a disconnecter and delayed fuses (phase and neutral) on the 230 V_{AC} power supply, with the following characteristics:
 - rated voltage: 230 V_{AC}
 - rated current (disconnecter): ±5 A
 - rated current (fuse): 2,5 A;

| | | |
|---|---|-----------------------------|
|  | GLOBAL STANDARD | Page 25 of 51 |
| | Remote Terminal Unit for secondary substations (UP) | GSTR001/1 Rev. 01 |

- ◊ a delayed fuse on the output (negative terminal) towards the battery, with the following characteristics:
 - rated voltage: 24 V
 - rated current: 20 A;
 - ◊ a bipolar circuit breaker (42-M), compliant with the Standard IEC 60947-2, with the following characteristics:
 - rated operating voltage: 24V
 - rated current (disconnecter): 20A
 - tripping curve: C
 - breaking capacity $\pm 4,5$ kA
 - opposite auxiliary contact 1 A at 24 V_{DC}

The opposite auxiliary contact will be used to send the remote alarm signal of "MOTOR FAILURE";

- ◊ a bipolar switch (42-I) with the following characteristics:
 - rated operating voltage: 24 V_{DC}
 - rated current: 2 A
 - breaking capacity: 2,5 kA;
 - ◊ a 12 socket connector for the exchange of the circuits with the UE (Table 18);
 - ◊ a 9 socket connector (Table 19) for the connection to the batteries and the terminal board of the RTU cabinet container;
 - ◊ a three-pole plug for the AC power supply input (connector type IEC C13 according to IEC 60320 standard).

The three-pole plug for the termination of the cable of the AC power supply is included in the supply.

Instead of a conventional fuse, the PTC thermistor (Figure 5) must be used to protect the auxiliary electronic circuits against over currents.

A switch must be placed at the rear of the power supply, for the selection of the AC voltage (100V/230 V) of the power supply.

The internal power supply connections must be chosen so as to avoid that the conductors can assume temperatures that exceed the set thresholds.

The wires must be N07V-K type according to CENELEC HD361:

- ◊ Insulation voltage U₀/U equal to 450/750V;
- ◊ Material: common PVC;
- ◊ Flexibility: flexible for stable installations, according to class 5 . IEC 228);

having non propagating fire characteristics, in compliance with IEC 60332-3 or CEI 20-22 (Italy only).

All connections should be marked with a collar marked with the reference to the corresponding terminal.

In particular, the connections to the battery poles, red for the positive and black for the negative, must have: a section $\pm 3\text{mm}^2$ ($\pm 1,5 \times 1,5 \text{mm}^2$), a length $\pm 80\text{cm}$ and, on the battery side, a collar label indicating the respective polarity. The ends of the connection to the battery poles must be left unterminated (properly

| | | |
|---|---|-----------------------------|
|  | GLOBAL STANDARD | Page 26 of 51 |
| | Remote Terminal Unit for secondary substations (UP) | GSTR001/1 Rev. 01 |

isolated one to the others and to the earth). They will be terminated at the moment of the battery installation.

7 COMMUNICATION PROTOCOLS AND TRANSMISSION EQUIPMENT

A detailed description of the communication protocols is provided in the document GSTR001/1/A3 (further details will be delivered after the tender has been awarded).

Some significant excerpts are recalled below, sufficient for a technical/economic evaluation of the topic.

The RTU can be able to communicate with the Center by adopting one of the two following communication standards:

- < IEC 60870-5-101, to the serial RS232 port;
- < IEC 60870-5-104, to the Ethernet or serial RS232 port.

7.1 IEC 60870-5-101 protocol

It is mandatory to refer to the profile detailed in the IEC 870-5-101 standard [profile structured according to three OSI layers: 7 (Application), 2 (Data-Link) e 1 (Physical)] for the "unbalanced transmission mode" and in compliance with the following clarifications/changes/additions:

Level 1:

The RTU uses the following transmission networks:

- < GSM 900 network;
- < DCS - 1800 network;
- < PSTN network;
- < Direct interconnection to dedicated circuits (4W Leased Line);
- < Radio;
- < Satellite network.

The DTE (RTU) must interface with these transmission networks by means of a physical interface to an external modem (external DCE).

In the case of PSTN, GSM, and 1800 DCS networks, a mechanism for connection restoration (with relating time-out) is provided, in case the line falls down.

Level 2:

- < V @ ^ Á Ô ^ } c ^ | Á æ } á Á c @ ^ Á Ü V W Á , ã | | Á | ^ •] ^ & c ã ç ^ | ^ Á] | æ ^ Á c
- < the address field must consist of two octets;
- < the % • ã } * | ^ Á & [} c | [| Á & @ æ | æ & c ^ | + Á { ~ • c Á } [c Á à ^ Á ~ • ^ á L
- < In the case of GSM/DCS and PSTN transmission networks:
 - o the parity bit of each character of 11 bits must be omitted (violation of the rule R2, each character will then be composed of 10 bits) with the activation of:
 - in case of GSM/DCS, a transparent mode, { ã • • ã
 - in case of PSTN, a V.42 error correction;
 - o starting idle character must be omitted (violation of the rule R1);
 - o During data reception, there must be discontinuity between the characters of the same frame (inter-character time window), according to the typical time-out of the GSM/DCS and PSTN transmission networks, as a function of the set out conditions of use.
- < In the case of spontaneous call (level 1) of the RTU, the "Master" launches an identification procedure for the recognition of the "Slave" and the subsequent start of data exchange;
- < The standard time-outs provided are valid starting from the validation time of the physical connection (level 1).

Level 7:

| | | |
|---|---|-----------------------------|
|  | GLOBAL STANDARD | Page 27 of 51 |
| | Remote Terminal Unit for secondary substations (UP) | GSTR001/1 Rev. 01 |

- < The application protocol must be implemented according to the instructions provided in the standard and according to the interoperability profile inside the reference document;
- < the chosen subset of messages, selected from the overall set provided in the standard, supports the implementation of the application activities, as illustrated in the reference document;

7.2 IEC 60870-5-104 protocol

For the management of the IEC 60870-5-104 protocol, different alternative methods of communication can be adopted, by means of local configuration:

1. communication via Ethernet port, or
2. communication via modem GPRS on RS232 serial port.

In the case 2, the RTU can be configured with TCP/IP and PPP protocol management. In this case, the GPRS modem is used as a simple transmission medium adapter (ISO/OSI level 1): the RTU must manage any upper ISO/OSI layer.

Level 1:

The RTU apparatus utilizes the following transmission networks:

- < IP Ethernet network;
- < GPRS network;

See the transmission equipment paragraph for further information.

Level 2:

- < V @ ^ Á Ô ^ } c ^ | Á æ } á Á c @ ^ Á Ü V W Á , ã | | Á | ^ •] ^ & c ã ç ^ | ^ Á] | æ ^ Á c
- < the address field must consist of two or three octets (in according to the interoperability profile) ;
- < c @ ^ Á % • ã } * | ^ Á & [} c | [| Á & @ æ ; æ & c ^ | + Á { ~ • c Á } [c Á à ^ Á ~ • ^ á
- < The time-out provided in the standard are valid starting from the validation time of the physical connection (level 1).

Level 7:

- < The application protocol must be implemented according to the instructions documented in the standard and according to the interoperability profile as inside the reference document;
- < the chosen subset of messages, selected from the overall set as detailed in the standard, supports the implementation of the application activities, as illustrated in the reference document;

7.3 Transmission equipment (DCE)

The RTU must be able to communicate with the Center via various means of communication (switched fixed telephone networks, 4-wire dedicated fixed telephone links, 900 MHz GSM networks or 1800 MHz DCS networks, radio networks, etc.). For each of the above mentioned systems, it might be necessary to adopt a different type of DCE. The RTUs must be implemented in order to make the DCE interchangeability as easy as possible; for this reason, the UE local reconfiguration actions, for varying items of the adopted DCE, must be minimized, or rather, reduced to zero. All of the tools which are useful to ENEL in order to interface the apparatus with the DCE of the latest generation must be made available.

7.3.1 GSM/GPRS modem

7.3.1.1. Physical interface to an external modem

The physical interface for the connection to an external modem must include the following features:

- < Type: ITU-T V.24/V.28;
- < Connector: ISO 2110, D type, 25-pole, male;
- < Managed interchange circuits: see Appendix.

| | | |
|---|---|-----------------------------|
|  | GLOBAL STANDARD | Page 28 of 51 |
| | Remote Terminal Unit for secondary substations (UP) | GSTR001/1 Rev. 01 |

7.3.1.2. Data interchange with the modem

The data interchange between the RTU and the modem must comply the following instructions:

- ◁ Transmission rate of reference data: 9600bps; nonetheless, the RTU must be designed to operate at higher speeds also, up to a maximum of 115.2 kbps, whereas other transmission systems and technologies are able to support them.
- ◁ Data format: asynchronous transfer mode, 1 start bit, 8 bit data, no parity bit, 1 stop bit.
- ◁ Flow control: software, by using DC1 . DC3 (XON - XOFF) characters, and hardware, by using C.106 (CTS) and C.105 (RTS) circuits.

7.3.1.3. Modem management

Modem functionalities must be handled by the RTU according to a standard mode:

- ◁ AT issues (GSM 07.05, GSM 07.07, V.25ter);
- ◁ V.25bis.

The DCE GSM/DCS connection cable, which is always included in the supply of each UE, must be at least 2m long, and must include the following:

- ◁ a D25 type connector, female poles, on the RTU side;
- ◁ a D9 type connector, male poles, on the GSM modem side.

| To the modem (9 pin type D Male) | | To the RTU (25 pin type D female) | |
|----------------------------------|---------------------|-----------------------------------|-----|
| Pin | Signal denomination | Signal denomination | Pin |
| 3 | 103 | 103 | 2 |
| 2 | 104 | 104 | 3 |
| 7 | 105 | 105 | 4 |
| 8 | 106 | 106 | 5 |
| 6 | 107 | 107 | 6 |
| 5 | 102 | 102 | 7 |
| 1 | 109 | 109 | 8 |
| 4 | 108 | 108 | 20 |
| 9 | 125 | 125 | 22 |

Table 6 – Signal pinouts between DTE and DCE, in the case of use of GPS/GPRS Modem

The DCE connection cable must have a length equal to at least 1m, and it must be equipped with the following connectors:

- ◁ a D25 type connector, female poles, on the RTU side;
- ◁ a D25 type connector, male poles, on the PSTN Modem side.

The DCE (PSTN type) connection cable must be provided as long as it is requested in the related order.

| To the modem (25 pin type D Male) | | To the RTU (25 pin type D Female) | |
|-----------------------------------|---------------------|-----------------------------------|-----|
| Pin | Signal Denomination | Signal Denomination | Pin |
| 2 | 103 | 103 | 2 |
| 3 | 104 | 104 | 3 |
| 4 | 105 | 105 | 4 |
| 5 | 106 | 106 | 5 |
| 6 | 107 | 107 | 6 |
| 7 | 102 | 102 | 7 |
| 8 | 109 | 109 | 8 |
| 9 | + V _{DC} | + V _{DC} | 9 |
| 10 | - V _{DC} | - V _{DC} | 10 |
| 15 | 114 | 114 | 15 |
| 17 | 115 | 115 | 17 |
| 18 | 141 | 141 | 18 |
| 20 | 108 | 108 | 20 |
| 21 | 140 | 140 | 21 |
| 22 | 125 | 125 | 22 |
| 24 | 113 | 113 | 24 |
| 25 | 142 | 142 | 25 |

Table 7 Signal pinouts between DTE and DCE, in the case of use of PSTN Modem

8 TESTING AND INSPECTION

The testing and certification process for the UP and its components must be executed according to Enel Global Standard **GSCG002 - Technical Conformity Assessment**. That Global Standard describes the procedures for technical & [] ~ [] { ã c ^ Á (hereinafter, { Á ^ % Vc Ô CE + D Á [~ Á & [{] [} ^ } c • (directly or indirectly) to all Enel Global Infrastructure and Networks Countries.

Before starting the supply, the UP æ } á Á ã c • Á & [{] [} ^ } c • Á { ~ • c Á | ^ & ^ ã ç ^ Á c according to GSCG002 prescriptions.

8.1 Overview of the tests required for the RTU and its components

The following tests must be executed onto each component (UE e PSBC) of the RTU:

- 1) Visual inspection;
- 2) Tests of insulation and dielectric strength;
- 3) Check of all of the functionalities;
- 4) Stability check (PSBC only);
- 5) Electromagnetic interference immunity test;
- 6) Thermal behavior test (PSBC only);
- 7) Climatic tests;

| | | |
|---|---|-----------------------------|
|  | GLOBAL STANDARD | Page 30 of 51 |
| | Remote Terminal Unit for secondary substations (UP) | GSTR001/1 Rev. 01 |

The above listed tests must be performed in Accredited Laboratories according to the current standards.

Testing procedures can be classified in:

- a) type test, with the aim to verify the perfect compliance of a production specimen with the technical specifications detailed in the present document;
- b) acceptance test, with the aim to control the essential characteristics of each device of the supply.

8.2 Type tests

The type tests are comprehensive of those which are indicated in the previous paragraph (1 through 7), including the software tests that are used for the calibrations and check of the various thresholds.

The supplier must keep and provide ENEL access to the documentation which attests to the success of the execution of the type tests.

8.2.1 Visual inspection

It is mandatory to verify the absence of visible manufacturing defects, the accuracy of construction, the compliance of the dimensions of all of the RTU components with those indicated in the current specification as well as the prescribed degree of protection.

An appropriate inspection must be performed on the power connectors, in order to verify that the insulating parts were manufactured well.

8.2.2 Tests of insulation and dielectric strength

The aim of the tests is to verify the dielectric strength amongst the independent circuits of the power supply.

Each test must be performed by applying a specific voltage value (corresponding to the level specified for each circuit) to each couple of circuits that are listed below, whereas the remaining circuit is grounded

- a) AC power supply input (level 4);
- b) Signaling output and 24 V_{DC} power supply output (level 3);

The voltage level must be equal to the prescribed value for each circuit.

The prescribed tests are listed below and they all have to be executed according to the methods and values defined in the corresponding reference standard EN 60255-5:

| | | | |
|--|------------------------|---|---------|
| Impulse withstand test | Overvoltage category 4 | AC power supply inputs, | PSBC |
| Impulse withstand test | Overvoltage category 3 | Inputs, outputs and 24V _{DC} input | PSBC\UE |
| Dielectric strength test | AC test voltage 2 kV | AC power supply input | PSBC |
| Measurement of the Insulation resistance | - F € € Á T Á oc[Á Í | AC Power supply | PSBC |
| Measurement of the Insulation resistance | - F € Á T Á cõç Á Í € | Inputs, outputs, DC Power supply | PSBC\UE |

Table 8 - Insulation Tests in compliance with EN 60255-5

8.2.3 Check of all of the functionalities

The regular performance of all of the prescribed functions must be verified, as well as the correct issue of the related signals, in correspondence to the prescribed intervention/nonintervention limits.

| | | |
|---|---|-----------------------------|
|  | GLOBAL STANDARD | Page 31 of 51 |
| | Remote Terminal Unit for secondary substations (UP) | GSTR001/1 Rev. 01 |

8.2.3.1. UE

All the functional characteristics described in the previous chapters of this document and in the other GSTR001 technical documents must be checked.

In particular, it is important to verify:

- < the integration of the RTU with the Central System for each specific IEC 60870-5 profile described in the GSTR001/1/A3 specification.
- < The automations described in the confidential documents

All these tests must be performed in Enel laboratories located in Milan, in Bari, in Barcelona (or in any other place indicated by Enel), at the expense of the supplier.

The supplier will organize the test plan as well as a detailed list of all of the tests, which must be approved by Enel.

This is mandatory, to proceed to a systematic and comprehensive check of the functionalities implemented.

8.2.3.2. PSBC

The tests on the PSBC must be executed at the rated voltage and without any loads or batteries connected.

The rectifier performance has to be checked also in the case of voltage interruptions (the first for a duration of 0.3 s, and the second for 180s): in this case the rectifier must return to its normal operating mode, without over voltages exceeding the prescribed threshold.

In particular, it must be verified that the maximum value of the current supplied, and its alternate component percentage, do not exceed the prescribed threshold, using a dummy load.

The functionality of the circuit controlling the maximum voltage of the rectifier (and the circuits supplying the rectifier itself) must be tested by connecting a proper battery to the power supply.

All of the functions, for which a software control is prescribed, must be also verified. For example, this is the case of the functions related to the regulation and testing of the output voltage, the regulation and testing of the battery threshold test, the exclusion/enabling of the battery test, etc.

8.2.4 Stability check (PSBC only)

The check of the stabilization limits must be carried out on the basis of the information reported in the table below:

| | |
|--|-----|
| Steady state stability (for simultaneous variations of the grid voltage from 90% to 120% of the rated value, under any loading condition from 0% to 100%): | ±1% |
| Dynamic state stability (for load steps that are equal to ±25% of half of the PSBC rated current): | ±5% |

Table 9 - Stability check

8.2.5 Electromagnetic interference immunity test

The aim of these tests is to verify the correct operation of either the PSBC or the UE, which are subjected to the application of various electromagnetic phenomena.

Emission limit tests must follow hereinafter, and be compliant with the following:

| | | | |
|---|---|--|-----------------------------|
|  | GLOBAL STANDARD | | Page 32 of 51 |
| | Remote Terminal Unit for secondary substations (UP) | | GSTR001/1 Rev. 01 |

| | | | |
|---|---------|---|---|
| Ring Wave | level 2 | IEC 61000-4-12:2006 | Local ports |
| Ring Wave | level 3 | IEC 61000-4-12:2006 | Field ports |
| Damped oscillatory waves | level 2 | IEC 61000-4-18:2006 | Field ports, Local ports, AC & DC Power supply |
| Fast transient/burst | level 3 | IEC 61000-4-4:2012 | Local ports, Ground, AC&DC input and Output |
| Fast transient/burst | level 4 | | Field ports |
| Surge 1,2-50/8-20 | level 3 | IEC 61000-4-5:2014 | AC&DC input and Output |
| Power frequency magnetic field | level 3 | IEC 61000-4-8:2009 | DC input and Output |
| Power frequency magnetic field | level 3 | IEC 61000-4-8:2009 | Local ports |
| Power frequency magnetic field | level 4 | IEC 61000-4-8:2009 | Field ports |
| Radiated, radio-frequency, electromagnetic field | level 3 | IEC 61000-4-3:2006 +AMD1:2007 CSV Consolidated version | Field and local ports, Ground, AC&DC inputs and outputs |
| Radiated, radio-frequency, electromagnetic field (digital radio telephones) | level 3 | IEC 61000-4-3:2006/ISH1:2008 | |
| Test voltage level at main frequency | level 3 | IEC 61000-4-16:1998n+AMD1:2001 CSV Consolidated version | Field and local ports, Ground, AC&DC inputs and outputs |
| Conducted common mode disturbances in the frequency range 0 Hz to 150 kHz | | | |
| Conducted disturbances induced by radio-frequency fields | level 3 | IEC 61000-4-6:2013 | Field and local ports, Ground, AC&DC inputs and outputs |

Table 10 - EMC Reference Standards

All the EMC tests must be performed, as indicated in the table above, in laboratories which are accredited according to the current standards.

8.2.5.1. UE

With reference to the above mentioned Standards, the tests to be performed onto the UE refer to the port classification listed below:

- USB port, RJ45, RS232 to DCE, power port: must be intended as local ports;
- RC output ports, RS and TM ports, field power port must be intended as field ports.

8.2.5.2. PSBC

With reference to the above mentioned Standards, the tests to be performed onto the PSBC refer to the port classification listed below:

- the 24 V_{DC} output port, the USB port must be intended as local ports;
- the 230/100 V_{AC} input port must be intended as field ports.

| | | |
|---|---|-----------------------------|
|  | GLOBAL STANDARD | Page 33 of 51 |
| | Remote Terminal Unit for secondary substations (UP) | GSTR001/1 Rev. 01 |

8.2.6 Thermal behavior test (PSBC only)

The power supply thermal map must be measured at the prescribed maximum values of the input/output parameters; the test must be executed under standard climatic conditions, as reported below:

- < Temperature: 15 \leq 35 °C;
- < Atmospheric pressure: 86 \leq 106kPa;
- < Relative humidity: 45 \leq 75 %

The over temperature values, measured close to the each component, must be used to verify that, at the maximum prescribed operating temperature, the maximum permissible temperature is not exceeded for that component.

The thermal map must also be used to define the time thermal constant, which must be used in the temperature variation test, described in the next paragraph.

8.2.7 Climatic Tests

The description of the tests on the TRU as well as the methodology of their execution are described in the standards recalled in the following table (Table 11 - Climatic Tests).

Two different tests must be executed, respectively with the PSBC switched OFF and ON.

During the tests, the clock stability must be verified.

| | | | | |
|--|-----------------------|--|---------------------|--|
| Switched off and rated powered equipment | Dry heat | +55 °C \pm 2 °C (16 hours) | IEC 60068-2-2:2007 | Environmental testing - Part 2-2: Tests - Test B: Dry heat |
| | Damp heat | +40 °C \pm 2 °C, RH = 93% \pm 3% (4 days) | IEC 60068-2-78:2012 | Environmental testing - Part 2-78: Tests - Test Cab: Damp heat, steady state |
| | Cold | (-10 \pm 3)°C (16 hours) | IEC 60068-2-1:2007 | Environmental testing - Part 2-1: Tests - Test A: Cold |
| | Change of temperature | TA = -10°C; TB =55°C; (3 hours+3 hours) | IEC 60068-2-14:2009 | Environmental testing - Part 2-14: Tests - Test N: Change of temperature |

Table 11 - Climatic Tests

At the beginning and the end of each test, as well as every 4h, during the execution of a single test, two issues of supply at the maximum current (with a duration of 30s each) must be caused.

During the N test, the above mentioned issues must be caused at the end of each evolution of the temperature from the minimum to the maximum value, and vice versa.

The maximum interval between two consecutive tests shall not exceed 3 days, except for the humid heat and cold tests, for which the maximum interval shall not exceed 2 hours, including the stabilization process.

In order to verify the correct operation of the power supply after the execution of all of the prescribed type tests, the following tests must be repeated:

- 1) Visual inspection;
- 2) Tests of insulation and dielectric strength;
- 3) Check of all of the functionalities;

| | | |
|---|---|-----------------------------|
|  | GLOBAL STANDARD | Page 34 of 51 |
| | Remote Terminal Unit for secondary substations (UP) | GSTR001/1 Rev. 01 |

8.2.8 Mechanical tests

The tests to be executed on the RTU, as well as the related methodology of the execution, are described within the standards recalled in the following table.

| TEST | DESCRIPTION | REMARKS |
|--|--|--|
| STATIONARY VIBRATION (SINUSOIDAL) | <ul style="list-style-type: none"> < Displacement amplitude (mm) : 0,75 < Acceleration amplitude (m/s²) : 10 < Frequency range (Hz): 10-500 < Duration: 5 cycles per axis < Fixing points: those of the standard mounting structure, considering the UP full equipped without batteries. < Acceptance criteria: Correct operation of the device during the test (e.g. execution of open/close commands on a switch) | Reference standard: EN 60068-2-6 (method Fc) |
| STATIONARY VIBRATION (RANDOM) | <ul style="list-style-type: none"> < Tab.A2 . Category 2 (EN 60068-2-64) < Duration: 0.5 hours per axis (3 axis) < Fixing points: as in standard shipping position without package. < Acceptance criteria: No damage of the device | Reference Standard: EN 60068-2-64 (method Fh) Category: 2 (transportation-water, trailers, lorries, in areas with well developed road systems) |

Table 12 - Mechanical test

8.3 Acceptance tests

Within the overall set of type tests, a subset of tests will be selected (for example, the insulation and dielectric strength tests). The execution of this set of type tests is mandatory for the acceptance of each item of supply.

For each device supplied, a certificate must be provided, certifying the success in the execution of the acceptance test.

For this purpose, the manufacturer must implement/obtain a capability to automatically perform the subset of tests for each item.

All the tests included in the Automatic Testing System must be agreed upon with ENEL in advance.

8.3.1 Preliminary checks

- < Check of the RTU 24V DC supply voltage:
- < Tolerance check, with powered base unit.

Check of the motors 24V DC supply voltage:

- < Tolerance check with maximum load.

Upload of the testing configuration:

The testing configuration must be performed in order to verify all of the available input and output

| | | |
|---|---|-----------------------------|
|  | GLOBAL STANDARD | Page 35 of 51 |
| | Remote Terminal Unit for secondary substations (UP) | GSTR001/1 Rev. 01 |

Check of correct RTU initialization:

- ◁ Link which opens on the visualization channel, with request and check of the internal diagnostic status.

Check of the PC connection functionality:

- ◁ A check of the PC connection functionality to the UE and PSBC ports.

8.3.2 Functional check

Serial port check:

- ◁ The basic electrical functionality of the port must be verified.

Remote signal check:

- ◁ Electrical functionality check in open/close conditions.

Remote control check:

- ◁ Check of the electrical functionality of closing remote controls and relative execution time (the latter to be done only on the first remote control).

Telemetry check:

- ◁ Parametric check of the single remote measurements to the following values: -6mA, 4mA, 0mA, 6mA, 20mA.

8.3.3 Automatic Testing System (SCA)

The Automatic Testing System mentioned in 8.3 must be produced so as to allow the testing of:

- Individual RTU components (PSBC and UE), as described in the paragraphs 8.3.1. and 8.3.2
- The overall RTU.

The same Automatic Testing System shall be used to perform the automatic test on spare parts.

The supplier must provide a detailed list of the tests to be executed automatically, that have to be checked and approved by ENEL.

The compliance of the Automatic Testing System with the documentation provided by the supplier and approved by ENEL must be certified by an **accredited third-party authority**.

9 SUPPLY REQUIREMENTS

9.1 Voltage selector switch in the PSBC

In case of pole mounted installations, the input voltage to PSBC can be provided by a transformer having the secondary winding voltage: 230V_{AC} or 100V_{AC}. The choice between a 100 V and 230 V_{AC} power supply must be possible by means of a selector switch, positioned at the rear (see also **Paragraph 6.2** for power supply characteristics).As default position, **the power supply must be provided with the selector switch set to 230 V_{AC}.**

| | | |
|---|---|-----------------------------|
|  | GLOBAL STANDARD | Page 36 of 51 |
| | Remote Terminal Unit for secondary substations (UP) | GSTR001/1 Rev. 01 |

9.2 TCA documents and Manuals

9.2.1 TCA documents

The Enel technical organization unit in charge of the Technical Conformity Assessment of the UP will supervise the technical documentation and the execution of the functional tests required to receive the

All the technical documentation required during that process shall be in local language of Enel technical organization unit in charge of the TCA for the RTU or in English. The TCA documents that shall be delivered include:

- ◁ **Type A documentation** (Not confidential documents used for product manufacturing and management from which it is possible to verify the product conformity to all technical specification requirements, directly or indirectly).
- ◁ **Type B documentation** (Confidential documents used for product manufacturing and management where all product project details are described, in order to uniquely identify the product object of the TCA). This type of documentation must be delivered only to the Enel technical organization unit in charge of the TCA
- ◁ **TCA dossier** (Set of final documents delivered by the Supplier for the TCA)
The supplier shall provide the TCA Dossier on digital support.

9.2.2 Manuals

The supplier shall provide on digital support all the end-user manuals of the UP and its components (e.g. operation, maintenance and installation manual, electric schemes, overall dimensional drawings, plate drawing, product colored pictures, etc).

All the manuals shall be in the local language of the UP destination country.

9.2.3 Safety warnings on Plate

The safety warnings required in the plate of the UP and its components must be written in the local language of the UP destination Country.

10 AMBIENT OPERATING CONDITIONS

The apparatus provided must be in compliance with the operating conditions listed below:

- ◁ Ambient temperature limit in the range of $-10 \div 55$ °C;
- ◁ Atmospheric pressure in the range of $70 \div 106$ kPa;
- ◁ Humidity limit of 93% at the max ambient temperature;
- ◁ Storage temperature in the range of $-25 \div 70$ °C.

11 ELECTROMAGNETIC COMPATIBILITY

11.1 Immunity requirements

The UE and the PSBC panels must be compliant with the current standards on EMC.

11.2 Emission limits

The Power supply must be in compliance with the current regulations on electromagnetic noise emission limits, and in particular the UE must be in compliance with:

~ **CISPR 22:2008**: Information technology equipment - Radio disturbance characteristics - Limits and methods of measurement (international standard);

| | | |
|---|---|-----------------------------|
|  | GLOBAL STANDARD | Page 37 of 51 |
| | Remote Terminal Unit for secondary substations (UP) | GSTR001/1 Rev. 01 |

“ **CEI EN 55022:2014-02:** Information technology equipment - Radio disturbance characteristics - Limits and methods of measurement (instead of CISPR 22 for CENELEC Countries).

“ **IEC 61000-6-4:2006-07:** Electro-magnetic compatibility (EMC) - Part 6-4: Generic standards - Emission standard for industrial environments;

12 SAFETY REQUIREMENTS

Each component of the RTU, including the non-electrical ones, must be in compliance with all of the current safety regulations (where applicable).

13 SOFTWARE

13.1 Remote connection with the Center

The supplier must interface with the Center via the software package, made available by ENEL.

The procedures of data exchange, related to each required activity, must fully operate automatically and without operator intervention.

Arrangements (in the processes of exchange and/or coding of data) must be adopted, which can provide a level of data integrity equivalent to I₃ (CEI-EN 60870-5-1) for the execution of remote controls.

Each activity must include the opening and closing procedure of the Communication Session; this procedure must be performed automatically also, without any operator involvement, and it must be performed also to prevent unwanted access to the system, by using a security procedure based on the exchange of dynamic passwords, which will be provided especially by ENEL.

13.2 Remote programming and configuration

A suitable software module must be provided to perform remote configuration / upgrade for one or more UEs (management of lists of devices) is also required, by means of both the Center and the modem normally used for remote control or of a standard PC with a modem.

13.3 Local programming and configuration

The local operations of diagnostics, programming and configuration of the UE will be carried out through a USB 2.0 port, positioned in front.

For this purpose, an appropriate program "RTU Configurator" (see Annex 1) must be provided, which is suitable to be run on a laptop PC equipped with Windows 7 or Windows 10 64 bit, allowing communication with the UE, via the local port of configuration (USB).

Monitoring input/output signals and automatisms

A "RTU Viewer" program must be available through the configuration/programming laptop, which allows the activation of the following functions at least:

- < status monitoring of the digital inputs;
- < status monitoring of the analog inputs;
- < status monitoring of the control outputs (relay);
- < status monitoring of the digital outputs;
- < on-line monitoring of the transitions between states of the automatisms for each switchgear (with visualization and recording of the transition sequence);
- < control launch for the opening/closing of the IMS/switches and the switching-off of the automation systems;
- < local downloading of the Events-and-Measures Buffer;
- < monitoring of the operating status of the link (Initialization in progress, waiting for a connection, connected)

| | | |
|---|---|-----------------------------|
|  | GLOBAL STANDARD | Page 38 of 51 |
| | Remote Terminal Unit for secondary substations (UP) | GSTR001/1 Rev. 01 |

The user interface must be represented by a screen which includes the following information at least:

1. the status of the various signals (opening/closing of each switchgear, intervention of the associated RGDM or RGDAT, feeder and busbar voltage Presence/Absence, etc..)
2. online values of the measurements;
3. the possibility of sending commands:
 - < opening/closing of a switchgear;
 - < switching-off of the automation systems corresponding to the selected IMS;
 - < downloading Events Buffer;
 - < downloading Measurements Buffer.
4. Significant information related to automation:
 - < switched on/off automation systems;
 - < temporary inhibition of Automatic Opening;
 - < Second reclosing from UP;
 - < Inhibited automation system.

Switchgear opening and closing commands sent from the screen must be treated, for automatism and controls, as remote controls from the Center (when the substation is locally operated, it must not be possible to control any switchgear movement from the screen).

The implementation of commands (open/close of switchgear; automatism switch-off; Download buffer) sent from the screen must cause the emission of a spontaneous call which cannot be disabled.

The download of the events from the local file system and/or measurements buffer must not clear its content, which, nonetheless, will be sent back to the Center in the event of a subsequent positive connection.

During the download process of the Buffer, the related virtual controlled on the screen must blink, in order to enable the user to check the progress of the operation.

For on-line monitoring of the transitions between automatism states, for each IMS, (with visualization and possibility of recording the sequence of transitions) a proper man/machine interface must be agreed upon with ENEL.

| | | |
|---|---|-----------------------------|
|  | GLOBAL STANDARD | Page 39 of 51 |
| | Remote Terminal Unit for secondary substations (UP) | GSTR001/1 Rev. 01 |

14 GENERAL PRESCRIPTIONS

14.1 Reliability

14.1.1 Normative references

The following terminology is defined in the standard IEC 50. IEC standards published by TC56 prescribe, in a detailed manner, methodologies to be applied in order to define, standardize and verify the reliability requisites of the various equipment, as well as of the items/systems in their entirety.

14.1.2 Formulation of the reliability requirements

In the remainder, the "useful life" of the device is the time that elapses between the end of the period of "early failures" and the beginning of the "faults for aging" one. The duration of the useful life coincides, therefore, with the "period of constant failure rate."

The period of early failures is intended to be zero, or terminated at the time of delivery. This is because the Supplier must implement and provide documentary evidence of all of the possible measurements which are useful to eliminate child mortality.

- “ The supplier must therefore certify that the equipment was already in the constant failure rate period since the time of delivery.
- “ The failure rate must be declared by the Supplier, according to the data of the project (by the calculation shown in the documentation) and must not exceed 3.5% per annum for the power supply/battery charger, and 2.5% per annum for the UE, having operated within the prescribed climatic and environmental conditions.
- “ The minimum period of constant failure rate, i.e. of the useful life, must be at least 10 years.
- “ For the purposes of the analysis of failure data, it is intended that any restoration (i.e. repair or maintenance) does not change the failure rate during the useful life.

For the reliability analysis during the useful life, the failures which are not attributable to improper use, or incorrect operation, are deemed to be "relevant failures"; in this regard, the Supplier must define, in detail, the scope of use and the eligible maneuvers for the product.

14.1.3 Verification tests of compliance with the declared failure rates

ENEL will agree to the modalities of analysis and verification of all of the data needed to monitor the reliability required throughout the period of useful life.

In this regard, the modalities of logging, classifying (relevant or irrelevant failures), and certifying the maintenance and repair interventions performed by the Supplier will be defined,

In accordance with ENEL, the Supplier must put a computerized archive in place and provide quarterly data on the failure rate, which is measured on the supplied equipment.

ENEL is equipped with an archive where the records (preventive or following a failure) of maintenance interventions are held, in order to perform control checks.

14.2 Project technical documentation

Before the installation of the equipment, the supplier must prepare a project documentation to be submitted to ENEL for approval. This project documentation must list in detail all of the solutions adopted by the supplier in order to ensure the required functionality and reliability.

14.3 Spare parts

The spare parts will be defined in the request for proposal. All of the spare parts of the supplied equipment (including firmware and software) must be available for at least 10 years after the expiration of the warranty period.

| | | |
|---|---|-----------------------------|
|  | GLOBAL STANDARD | Page 40 of 51 |
| | Remote Terminal Unit for secondary substations (UP) | GSTR001/1 Rev. 01 |

14.4 Equipment documentation

The provider must produce detailed documentation of the operation, configuration and maintenance of the equipment, accompanied by either the wiring and topographic diagrams, or the lists of components. These documentation must be provided electronically.

| | | |
|---|---|-----------------------------|
|  | GLOBAL STANDARD | Page 41 of 51 |
| | Remote Terminal Unit for secondary substations (UP) | GSTR001/1 Rev. 01 |

15 APPENDIX

| ID_IN | PIN | Connector | Description | UE8 | UE16 |
|-------|-----|-------------------------------|---|-----|------|
| 0 | - | L/R selector | Local operating mode | 1 | 1 |
| 1 | - | L/R selector | Remote operating mode | 1 | 1 |
| 2 | - | input terminal Door Op | substation door opening | 1 | 1 |
| 3 | - | input terminal TR SD | transformer switch opening | 1 | 1 |
| 4 | 7 | PSBC/UE connector | Motor failure | 1 | 1 |
| 5 | 8 | PSBC/UE connector | MAINS failure/BVI | 1 | 1 |
| 6 | 9 | PSBC/UE connector | rectifier failure | 1 | 1 |
| 7 | 10 | PSBC/UE connector | Low V _{DC} | 1 | 1 |
| 8 | 11 | PSBC/UE connector | Battery Failure | 1 | 1 |
| 9 | 5/4 | i th SG connector | switch disconnecter closed | 8 | 16 |
| 10 | 5/9 | i th SG connector | switch disconnecter open | 8 | 16 |
| 11 | 1/2 | i th FPI connector | Overcurrent detection (FPI _{ov}) | 8 | 16 |
| 12 | 1/5 | i th FPI connector | Zero sequence current detection (FPI ₀) | 8 | 16 |
| 13 | 1/3 | i th FPI connector | remote signal | 8 | 16 |
| | - | remote signal input terminal | | | |
| Total | | | | 49 | 89 |

Table 13 – Remote Signals

| ID_OUT | PIN | Connector | Description | UE8 | UE16 |
|--------|------|-------------------------------|------------------------|-----|------|
| 0 | 12/8 | i th SG Connector | Remote Closing Control | 8 | 16 |
| 1 | 12/7 | i th SG Connector | Remote Opening Control | 8 | 16 |
| 2 | 7/8 | i th FPI Connector | Digital Output | 8 | 16 |
| Total | | | | 24 | 48 |

Table 14 – Remote Controls/Digital outputs

| | | |
|---|---|-----------------------------|
|  | GLOBAL STANDARD | Page 42 of 51 |
| | Remote Terminal Unit for secondary substations (UP) | GSTR001/1 Rev. 01 |

| ID_MEAS | PIN | Position | Description | UE8 | UE16 |
|---------|-----|--|---|-----|------|
| 0 | | T _{amb} Input/output terminal | 4 wire PT100 terminal for ambient temperature measurement | 1 | 1 |
| 1 | 4/6 | i th FPI connector | Telemeasuring enabled | 8 | 16 |
| | - | Telemeasuring input terminal | | | |
| Total | | | | 9 | 17 |

Table 15 – Telemeasurement Signals

| | | |
|---|---|-----------------------------|
|  | GLOBAL STANDARD | Page 43 of 51 |
| | Remote Terminal Unit for secondary substations (UP) | GSTR001/1 Rev. 01 |

AT COMMANDS OF THE DUAL-BAND MODEM GSM900/DCS1800

The following AT commands (in alphabetical order) are included among the features, performance, and requirements of the dual-band GSM900/DCS1800modem:

- +CME Mobile equipment result codes
- +CMS Message service failure result codes
- A/ Re-execute last command
- AT&C Set DCD signal
- AT&D Data Terminal Ready options
- AT&F Restore default configuration
- AT&S Set DSR signal
- AT&T Autotest
- AT&V Display current configuration
- AT&W Save current configuration
- AT+CBST Bearer type selection
- AT+CEER Displays why last call was disconnected
- AT+CLCK Facility lock
- AT+CMGD Delete messages
- AT+CMGF Message format
- AT+CMGL List messages
- AT+CMGR Read message
- AT+CMGS Send messages
- AT+CMGW Write message to memory
- AT+CMSS Send messages from storage
- AT+CNMI New message indication to terminal equipment
- AT+COPS Operator selection
- AT+CRLP Radio Link Protocol parameters
- AT+CSQ Display signal strength
- AT+ICF Character framing
- AT+IFC Local flow control
- AT+ILRR Display local port rate
- AT+IPR Set terminal equipment data rate
- ATA Manual answer an incoming call
- ATD Dial a telephone number
- ATDL Redial last telephone number
- ATE Echo
- ATH Hang up
- ATO Change from command mode to data mode
- ATS0 Auto-answer mode
- ATS3 Set the command termination character

| | | |
|---|---|-----------------------------|
|  | GLOBAL STANDARD | Page 44 of 51 |
| | Remote Terminal Unit for secondary substations (UP) | GSTR001/1 Rev. 01 |

- ATV DCE response format
- ATZ Load user profile.

DATA EXCHANGE CIRCUITS

- C.102 Signal Ground or Common Return
- C.103 Transmitted Data
- C.104 Received Data
- C.105 Request to send
- C.106 Ready for sending (Clear to Send)
- C.107 Data set ready
- C.108/2 Data terminal ready
- C.108/1 Connection data set to line
- C.109 Carrier detector
- C.113 Transmitter signal element timing (DTE source) [optional]
- C.114 Transmitter signal element timing (DCE source) [optional]
- C.115 Receiver signal element timing (DCE source) [optional]
- C.125 Ring Indicator.

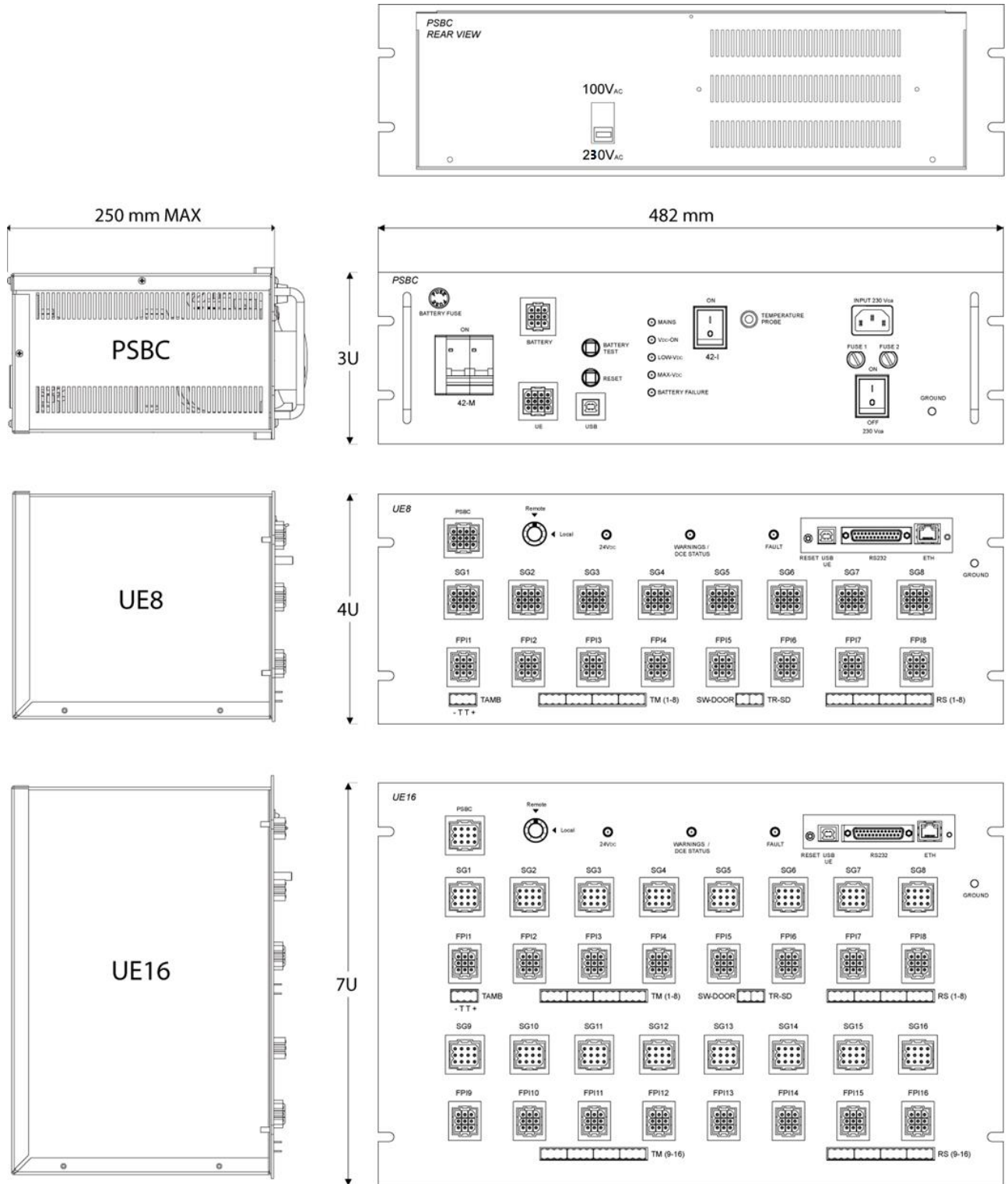

Figure 4 – Views of the chassis of the UE8, UE16 and PSBC

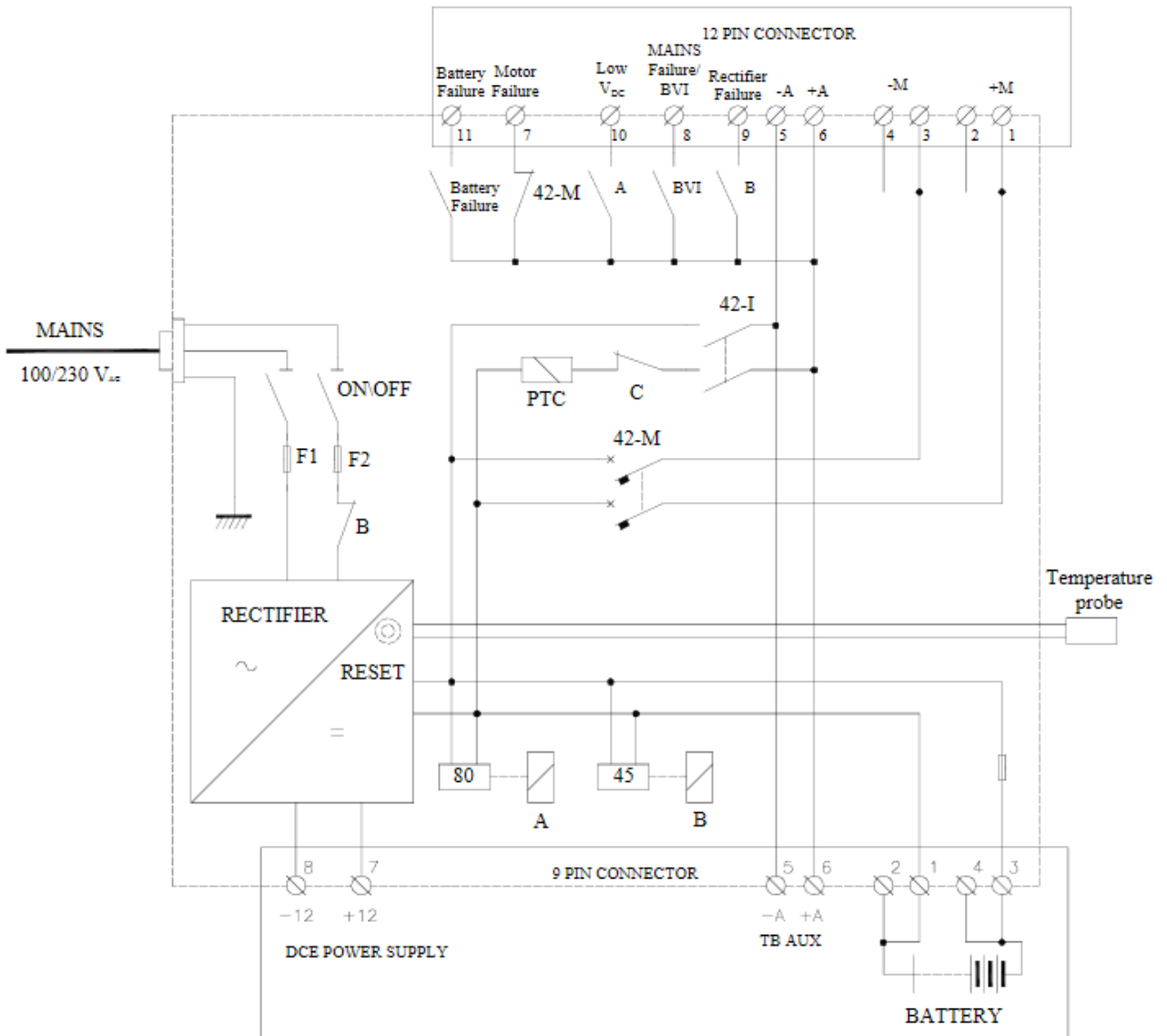

Figure 5 – Circuit diagram of the power supply

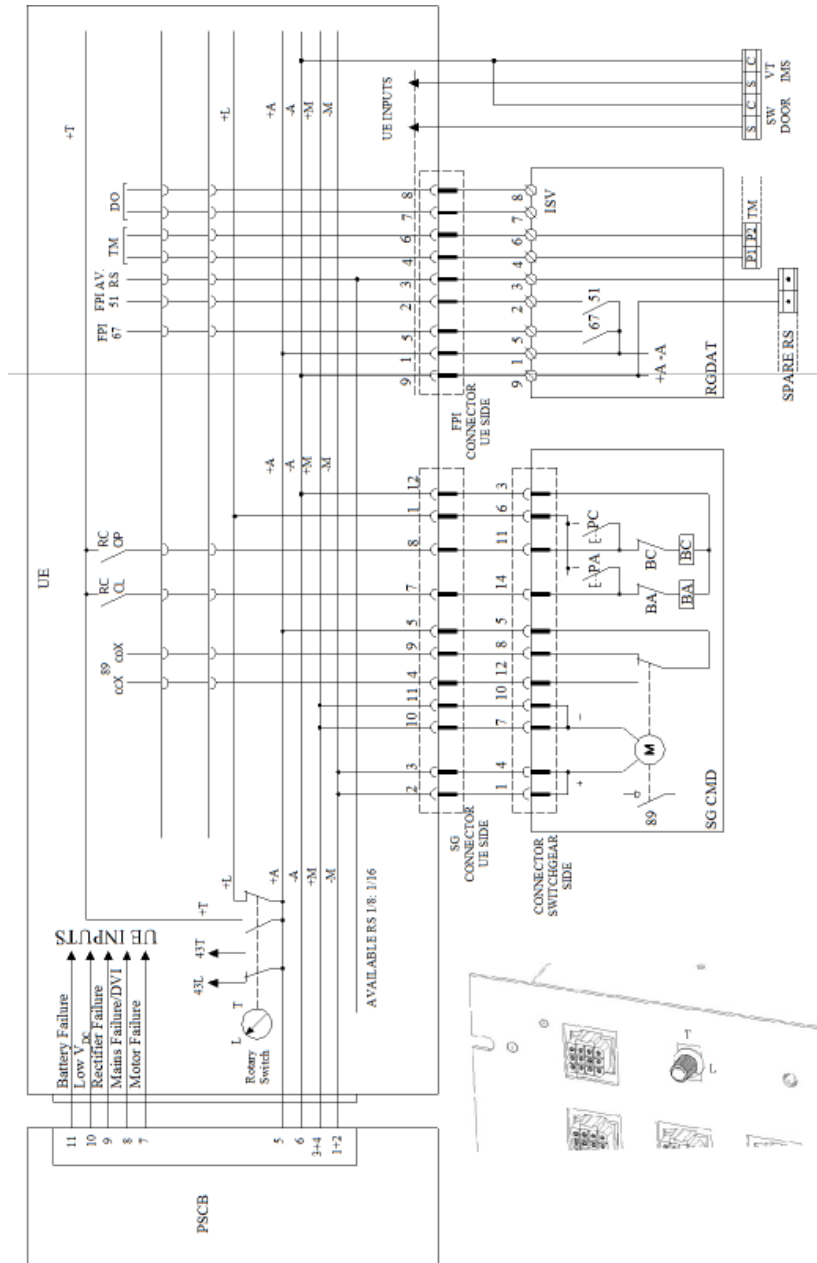



Figure 6 – Circuit diagram of the PSBC/UE field connections and rotary switch detail

| | | |
|---|---|-----------------------------|
|  | GLOBAL STANDARD | Page 48 of 51 |
| | Remote Terminal Unit for secondary substations (UP) | GSTR001/1 Rev. 01 |

| Pin | Name | Description | Pin | Name | Description |
|-----|--------|--|-----|--------|---|
| 1 | +L | Local controls power supply (+24 V _{DC}) | 7 | OP | Remote control opening |
| 2 | +M | Motor power supply (+24 V _{DC}) | 8 | CL | Remote control closing |
| 3 | +M | Motor power supply (+24 V _{DC}) | 9 | 89 cax | Remote signal of end position open SG |
| 4 | 89 ccx | Remote signal of end position closed SG | 10 | -M | Motor power supply (-24 V _{DC}) |
| 5 | RS Com | RS Common of the Switchgear | 11 | -M | Motor power supply (-24 V _{DC}) |
| 6 | | Not in use | 12 | -A | (-24 V _{DC}) Controls Common |

Table 16 – SG connector pinout (FLOATING PART)

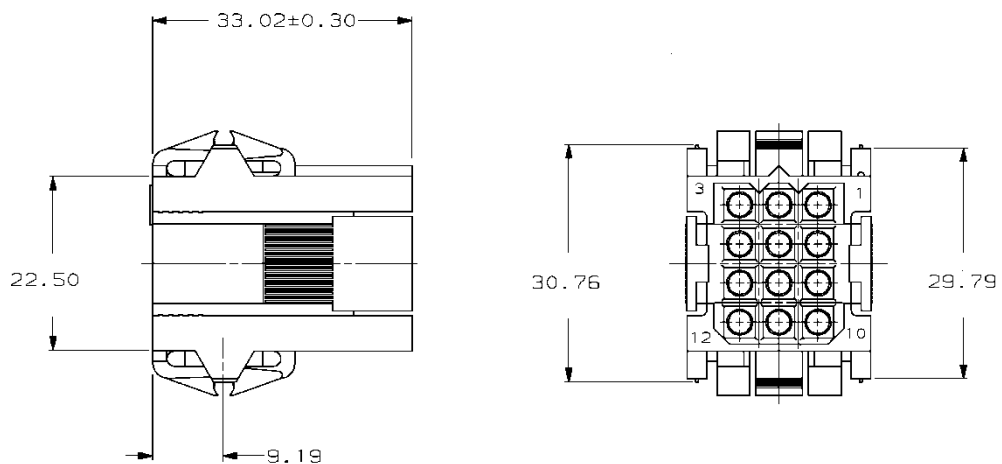

Figure 7 – Dimensional characteristics of the female 12 pin connector from switchgear

| Pin | Name | Description |
|-----|------------------|--|
| 1 | RS Com | Power supply (+24 V _{DC}) and Common |
| 2 | RS _{ov} | Overcurrent operate condition |
| 3 | RS | Spare RS |
| 4 | TM+ | Analog input (pole 1) |
| 5 | RS ₀ | Zero sequence current operate condition |
| 6 | TM- | Analog input (pole 2) |
| 7 | DO COM | Digital Output Common |
| 8 | DO | Digital Output |
| 9 | - | Power supply (-24 V _{DC}) |

Table 17 – FPI connector pinout (FLOATING PART)

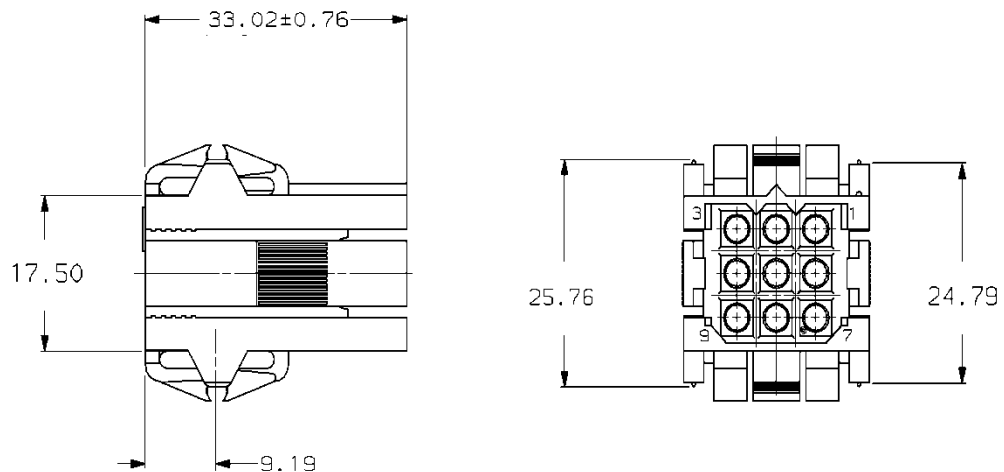



Figure 8 – Dimensional characteristics of the female 9 socket connector from RGDAT/RGDM

| | | |
|---|---|-----------------------------|
|  | GLOBAL STANDARD | Page 50 of 51 |
| | Remote Terminal Unit for secondary substations (UP) | GSTR001/1 Rev. 01 |

| Pin | Name | Description | Pin | Name | Description |
|-----|------|---|-----|---------------------|---------------------|
| 1 | +M | Motor Power supply (+24 V _{DC}) | 7 | Mot Fail | Motor Failure |
| 2 | +M | Motor Power supply (+24 V _{DC}) | 8 | Mains fail/BVI | Mains failure/BVI |
| 3 | -M | Motor Power supply (-24 V _{DC}) | 9 | Rect Fail | Rectifier Failure |
| 4 | -M | Motor Power supply (-24 V _{DC}) | 10 | Low V _{DC} | Low V _{DC} |
| 5 | -A | UE Power supply (-24 V _{DC}) | 11 | Batt Fail | Battery Failure |
| 6 | +A | UE Power supply (+24 V _{DC}) | 12 | - | - |

Table 18 – Pinout (floating and fixed part of the 12 pin connector, either power supply side or RTU side)

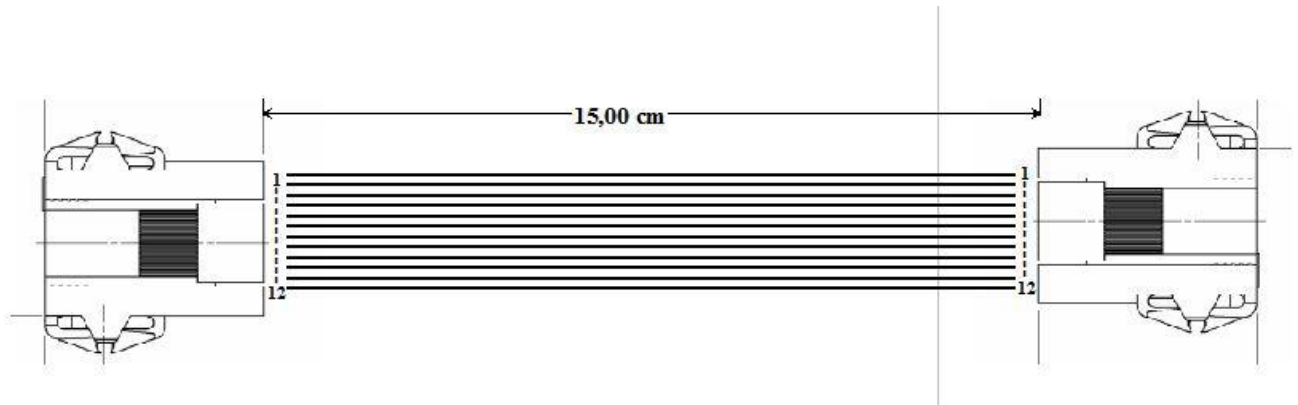



Figure 9 – Connection between PSBC and UE

| | | |
|---|---|-----------------------------|
|  | GLOBAL STANDARD | Page 51 of 51 |
| | Remote Terminal Unit for secondary substations (UP) | GSTR001/1 Rev. 01 |

| Pin | Name | Description |
|-----|---------------------|--|
| 1 | + Batt | Battery positive terminal(+24 V _{DC}) |
| 2 | + Batt | Battery positive terminal(+24 V _{DC}) |
| 3 | -Batt | Battery negative terminal(-24 V _{DC}) |
| 4 | -Batt | Battery negative terminal (-24 V _{DC}) |
| 5 | +A | Auxiliary Power supply |
| 6 | -A | Auxiliary Power supply |
| 7 | +12 V _{DC} | DCE Power supply(+12 V _{DC}) |
| 8 | -12 V _{DC} | DCE Power supply(-12 V _{DC}) |
| 9 | - | - |

Table 19 – Pinout (floating and fixed part of the 9 pin connector, power supply side)