

	GLOBAL STANDARD	Page 1 of 69
	LATTICE STEEL SUPPORTS FOR HIGH VOLTAGE LINES	GSCS001 Rev. 00 09/12/2020

LATTICE STEEL SUPPORTS FOR HIGH VOLTAGE LINES

Countries I&N	
Argentina	Federico Luis Cetrangolo
Brazil	Romulo Alves Moreira Sales
Chile	Daniel Alejandro González Sarkis
Colombia	Juan Carlos Gómez Cubillos
Italy	Luca Giansante
Peru	Roberto Sánchez Vargas
Romania	Vasilica Obrejan
Spain	Juan González Lara

	Elaborated by	Verified by	Approved by
Global I&N – O&M/NCS	J.M. Lopez Villena	R. Emma	M. Mazzotti

This document is intellectual property of ENEL Group distribution companies; reproduction or distribution of its contents in any way or by any means whatsoever is subject to the prior approval of the above mentioned companies which will safeguard their rights under the civil and penal codes. This document is for Internal Use.

Revision	Data	List of modifications
00	00/00/0000	First emission

	GLOBAL STANDARD	Page 2 of 69
	LATTICE STEEL SUPPORTS FOR HIGH VOLTAGE LINES	GSCS001 Rev. 00 09/12/2020

INDEX

1	SCOPE	5
2	LIST OF COMPONENTS	5
3	REFERENCE LAWS AND STANDARDS	5
3.1	Laws	5
3.2	European & International Standards	6
3.3	Local Standards	6
4	SERVICE CONDITIONS	6
5	TECHNICAL CHARACTERISTICS	7
5.1	General Characteristics	7
5.2	Tower outline and geometry	7
5.3	Function	9
5.4	Structural Design	9
5.4.1	Structural analysis.....	10
5.4.2	Limit Efforts.....	10
5.4.3	Deflection.....	10
5.5	Characteristic Strength	11
5.5.1	Standard Loads.....	11
5.5.2	Standard Load Cases.....	12
5.5.3	Security coefficient.....	13
5.5.4	Standard Strength.....	14
5.5.5	Standard Graphs.....	17
5.6	Standard Clearances	18

	GLOBAL STANDARD	Page 3 of 69
	LATTICE STEEL SUPPORTS FOR HIGH VOLTAGE LINES	GSCS001 Rev. 00 09/12/2020

5.6.1	Distance between phase conductors	18
5.6.2	Distance between phase conductors and earthed parts	19
5.7	Standard Height	20
5.8	Base Surface	20
5.9	Attachment point of conductor and earth wire	21
5.10	Maintenance Facilities	23
6	DENOMINATION OF SUPPORTS	23
6.1	Examples of denomination	25
6.2	Example of designation of support	26
7	CONSTRUCTION CHARACTERISTICS	28
7.1	General Characteristics	28
7.2	Materials	28
7.3	Welding	28
7.4	Connections	28
7.5	Anchor Stub	29
7.6	Corrosion protection	29
8	TESTING	29
8.1	Factory acceptance tests	29
8.1.1	Visual inspection	30
8.1.2	Dimensional verification	30
8.1.3	Galvanization verification	30
8.1.4	Inspection of welds	31
8.1.5	Material properties verification	31

	GLOBAL STANDARD	Page 4 of 69
	LATTICE STEEL SUPPORTS FOR HIGH VOLTAGE LINES	GSCS001 Rev. 00 09/12/2020

8.1.6	Weight verification.....	31
8.2	Type test	31
9	SUPPLY REQUIREMENTS.....	32
9.1	Packing.....	32
10	DOCUMENTATION	33
	LOCAL SECTION A - ENEL DISTRIBUCIÓN COLOMBIA	34
	LOCAL SECTION B - ENEL DISTRIBUCIÓN PERÚ	35
	LOCAL SECTION C - ENEL DISTRIBUCIÓN CHILE.....	44
	LOCAL SECTION D - ENEL DISTRIBUIÇÃO RIO, GOIÁS AND SÃO PAULO	45
	LOCAL SECTION E - E-DISTRIBUZIONE.....	46
	LOCAL SECTION F - EDISTRIBUCIÓN REDES DIGITALES.....	47
	LOCAL SECTION G - E-DISTRIBUȚIE BANAT, DOBROGEA AND MUNTENIA	48
	LOCAL SECTION H - EDESUR	53
	ANNEX A - STANDARD GRAPHS	54
	ANNEX B - TECHNICAL CHECK-LIST	67
	ANNEX C - LIST OF GLOBAL STANDARD CODES	68
	ANNEX D - COMMON LIST OF LOCAL CODES	69

	GLOBAL STANDARD	Page 5 of 69
	LATTICE STEEL SUPPORTS FOR HIGH VOLTAGE LINES	GSCS001 Rev. 00 09/12/2020

1 SCOPE

The aim of this document is to provide technical requirements for the supply of self-supporting lattice steel supports to be used in high voltage lines with rated voltage above 36 kV of the distribution and transmission networks of Enel Group Distribution Companies, listed below:

<i>Codensa</i>	<i>Colombia</i>
<i>Enel distribución Perú</i>	<i>Perú</i>
<i>Edesur</i>	<i>Argentina</i>
<i>e-distributie Banat</i>	<i>Romania</i>
<i>e-distributie Dobrogea</i>	<i>Romania</i>
<i>e-distributie Muntenia</i>	<i>Romania</i>
<i>e-distribuzione</i>	<i>Italy</i>
<i>Edistribución Redes Digitales</i>	<i>Spain</i>
<i>Enel distribución Chile</i>	<i>Chile</i>
<i>Enel Distribuição Ceará</i>	<i>Brazil</i>
<i>Enel Distribuição Rio</i>	<i>Brazil</i>
<i>Enel Distribuição Goiás</i>	<i>Brazil</i>
<i>Eletropaulo</i>	<i>Brazil</i>

This standard refers to towers predominantly made of angle members with bolted connections. Nevertheless, some clauses could be applied to other types of towers.

2 LIST OF COMPONENTS

The list of components with the main requirements, which is an integral part of the present document, is reported in the common list attached.

3 REFERENCE LAWS AND STANDARDS

The list of reference laws and standards are mentioned below in this document.

3.1 Laws

R.D. 223/2008 Reglamento sobre condiciones técnicas y garantías de seguridad en líneas eléctricas de alta tensión.

R.P.C. 305/2011 Reglamento europeo de productos de la construcción.

ITC-LAT-07 Instrucción Técnica Complementaria del Reglamento sobre condiciones técnicas y garantías de seguridad en líneas eléctricas de alta tensión.

	GLOBAL STANDARD	Page 6 of 69
	LATTICE STEEL SUPPORTS FOR HIGH VOLTAGE LINES	GSCS001 Rev. 00 09/12/2020

3.2 European & International Standards

EN 1090	Ejecución de estructuras de acero y aluminio.
EN 1992	Eurocódigo 2: Proyecto de estructuras de hormigón.
EN 1993	Eurocódigo 3: Proyecto de estructuras de acero.
EN 10025	Productos laminados en caliente de aceros para estructuras
EN 10056	Angulares de lados iguales y desiguales de acero estructural
EN 10149	Productos planos laminados en caliente de acero de alto límite elástico para conformado en frío.
EN 50341	Overhead electrical lines exceeding AC 1 kV
EN 60652	Ensayos mecánicos de estructuras para líneas eléctricas aéreas.
EN 60865	Corrientes de cortocircuito. Cálculo de efectos.
EN 61773	Líneas aéreas. Ensayos de cimentaciones de estructuras.
ISO 1461	Recubrimientos de galvanización en caliente sobre piezas de hierro y acero. Especificaciones y métodos de ensayo.
ISO 17025	Evaluación de la conformidad. Requisitos generales para la competencia de los laboratorios de ensayo y de calibración.
UNE-17115:2010	Elementos de fijación. Conjuntos de tornillo, tuerca y arandela para uso en apoyos metálicos para líneas eléctricas aéreas. Características dimensionales y mecánicas.
ASCE 10-15	Design of Latticed Steel Transmission Structures
IEC 60826:2017	Design criteria of overhead transmission lines
EN ISO 6892-1:2019	Metallic materials. Tensile testing. Part 1: Method of test at room temperature.

3.3 Local Standards

See Local Section.

4 SERVICE CONDITIONS

These structures are intended for use in electrical networks with nominal tension from 45 kV to 220 kV, as indicated in the table below.

	Unified voltage values U [kV]									
	220	150	138	132	115	110	69	66	60	45
I&N Argentina	X			X						
I&N Brazil			X				X			
I&N Chile	X					X				
I&N Colombia					X					
I&N Iberia				X		X		X		X
I&N Italy	X	X		X						
I&N Peru	X							X	X	
I&N Romania						X				
Tower Type Group	A	B					C			
	Argentina Chile Italy Peru	Argentina Brazil Chile Colombia Iberia Italy Romania					Brazil Iberia Peru			

5 TECHNICAL CHARACTERISTICS

5.1 General Characteristics

Latticed steel towers must hold conductors and ground wires of lines in such a way that electrical and mechanical requirements are met with acceptable levels of reliability and with due regard to safety of the public, durability, maintainability and appearance.

The above requirements shall take account environmental scenarios sufficiently severe to encompass all conditions which can be foreseen to occur during the working life of the towers.

They shall be designed to avoid human injuries or loss of life during installation and maintenance operations.

Towers will mainly hold one or two circuits and their corresponding earth wires, although they could hold more than these in case of necessity.

5.2 Tower outline and geometry

Depending the number of crossarms for conductors and earth wires and their disposition on the support there could be different configurations that form the outline of the tower.

The most usual are those indicated below:

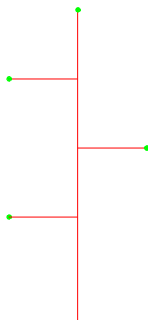

TRESBOL ILLLO

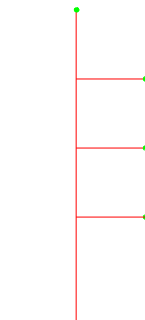

BANDERA

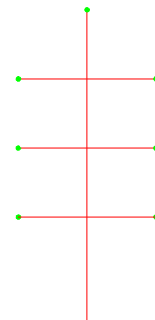

DOBLE BANDERA

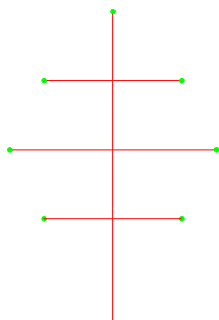

EXAGONO

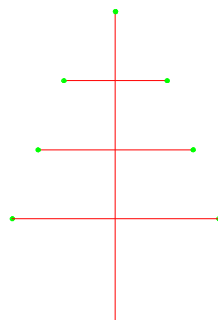

ABETO

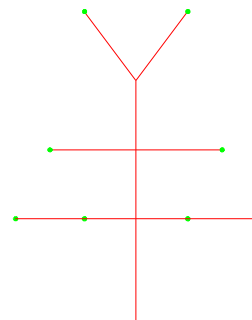

DANUBIO

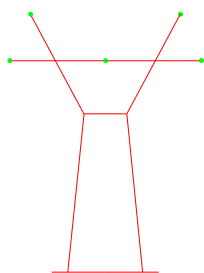

CAPA

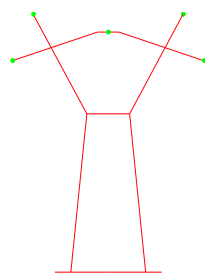

BOVEDA

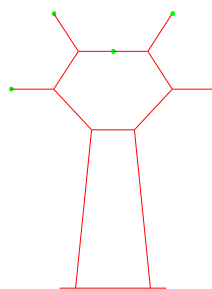

CABEZA DE GATO

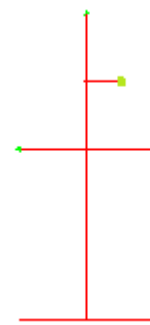

TRIANGULO

	GLOBAL STANDARD	Page 9 of 69
	LATTICE STEEL SUPPORTS FOR HIGH VOLTAGE LINES	GSCS001 Rev. 00 09/12/2020

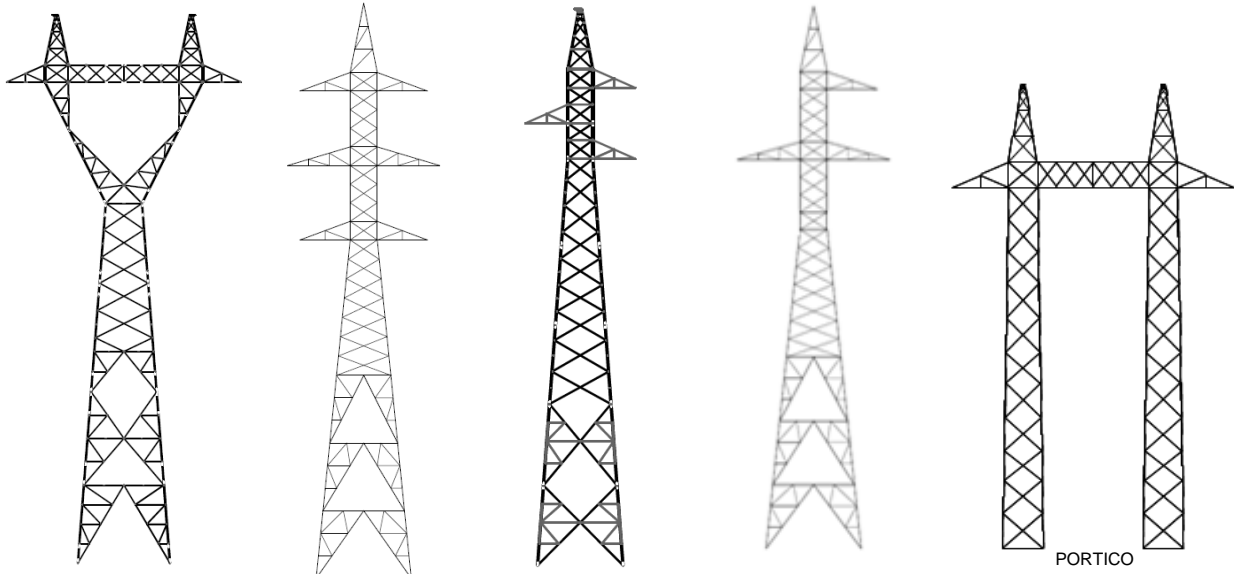

The standard configurations used on Enel distributions companies are the following:

- For single circuit: Tresbolillo
- For double circuit: Doble bandera.

Any other configuration must be indicated explicitly.

5.3 Function

According to the function in the line, towers can be classified as follows:

- L-Suspension: Tower with vertical insulation chains.
- M-Tension: Tower with horizontal insulation chains.
- G-Anchorage: Tension tower intended to provide a strong point along the line to avoid a progressive collapse (cascading).
- F-Terminal or end of line: The first and last tension towers of the line, which support longitudinally all the mechanical load of every conductor.
- Special: Towers with a function different to the previously indicated such as derivations, conversions to underground lines, etc.

According to the position in the line, towers can be classified as follows:

- Angle Tower: There is a change in line direction.
- Alignment Tower: There is not a change in line direction.

5.4 Structural Design

Structural design of towers shall meet requirements of EN-50341-1 or ASCE 10-15.

	GLOBAL STANDARD	Page 10 of 69
	LATTICE STEEL SUPPORTS FOR HIGH VOLTAGE LINES	GSCS001 Rev. 00 09/12/2020

At all crossarm levels and at changes of slope of leg members, horizontal bracings shall be provided, and the adequacy of their strength shall be proven.

The towers will be designed so that all parts are accessible for inspection and cleaning. Pockets or depressions that could store water should have drainage holes.

For all members which can be climbed and are inclined with an angle less than 30° to the horizontal, a load of 200 daN acting vertically in the centre of the member shall be assumed without any other loads.

The eccentricity of the connections of members at nodes shall be kept as small as possible.

5.4.1 Structural analysis

Supports are structures with some degree of hyperstaticity and their final calculated strength can be influenced by structure modelling.

Usually latticed steel towers are considered as pin jointed truss and beam structures. It can be assumed that enough precision is achieved when it is used a spatial model where the main bars and all bars that have “plain nodes” are modelled with beam elements and all the other with truss elements.

The internal forces and moments shall be determined using elastic global analysis, on the assumption that the stress-strain behaviour of the material is linear, irrespective of the stress level and may generally be determined using first order theory.

Concentrated loads must be considered applied at the attachment point.

Superficial or volumetric loads could be considered applied at all nodes of the model.

5.4.2 Limit Efforts

The limit stress of each angle element of the tower structure will be:

- For tensile stresses: The elastic limit of steel.
- For compression stresses: The buckling limit stress.

The slenderness ratio of elements to compression, as defined on ASCE 10-95, shall not exceed the following limits:

- For studs and crosspieces :150
- For braces, diagonals and other elements :200
- For redundant elements :250

5.4.3 Deflection

In any condition of use not exceptional and loads applied without overload factors, the maximum displacement at any point of the support calculation model may not exceed the following values:

- 1/30 times the maximum height of the support on the ground for supports type L.
- 1/50 times the maximum height of the support on the ground for the rest of the supports.

	GLOBAL STANDARD	Page 11 of 69
	LATTICE STEEL SUPPORTS FOR HIGH VOLTAGE LINES	GSCS001 Rev. 00 09/12/2020

5.5 Characteristic Strength

The strength of a support under a defined set of loads is determined by the strength of the element that first reach its damage limit under that set of loads. So, the total strength of a supports is related to the combination of loads resisted in every circumstance. Every set of loads is called a Load Case and there is a characteristic strength for a support in every Load Case.

The set of all characteristic strengths of one support for every load case considered is the characteristic strength that define this support.

5.5.1 Standard Loads

The loads involved in the determination of the support strength are the following:

- Loads transmitted by conductors and earth wires to the cross-arms at their attachment point. In case of conductor at the attachment point of the insulators that supports them.
On a tower with N attachment point for conductors and N_e attachment point for earth wires, those loads will be named like this:
 - L_i : Load transmitted by conductors to attachment point number i in the line direction (perpendicularly to the cross-arm).
 - T_i : Load transmitted by conductors to attachment point number i transverse to the direction of the line (parallel to the cross-arm)
 - V_i : Load transmitted by conductors to attachment point number i in vertical direction.
 - L_{ei} : Load transmitted by earth wires to attachment point number e_i in the line direction (same direction than L_i).
 - T_{ei} : Load transmitted by earth wires to attachment point number e_i transverse to the direction of the line same direction than T_i).
 - V_{ei} : Load transmitted by earth wires to attachment point number e_i in vertical direction.

- Pressure loads due to wind acting on the tower itself, supported over the surface of every exposed element of the support.
For structural analysis purpose, these loads could be considered as concentrated loads acting on the nodes of the towers. In any case, the sum of all these loads have to be equal or greater than the product of the wind pressure considered and the total area resulting from the projection of every element of the support (including cross-arms, plates, etc...) on a plane perpendicular to the wind direction.

- Own weight of support.

Unless otherwise specified, it is not necessary to consider seismic effects or fire resistance.

	GLOBAL STANDARD	Page 12 of 69
	LATTICE STEEL SUPPORTS FOR HIGH VOLTAGE LINES	GSCS001 Rev. 00 09/12/2020

5.5.2 Standard Load Cases

The loads cases to consider in order to define the characteristic strength of a supports are these:

- Load Case 1: This case is useful to define the characteristic strength of a supports when pressure loads, like those of wind, are acting on the tower itself. Loads considered in this case are:
 - Own weight of support.
 - Wind pressure on the tower itself equal to 170 daN/m². (120 km/h)
 - Loads L_i , T_i and V_i equals in every attachment point for conductors.
 - Loads L_{ei} , T_{ei} and V_{ei} equals in every attachment point for earth wires.
- Load Case 2: In this case there are not pressure loads on the tower itself. It is useful to represent cases of unbalanced span's tension, ice on conductors or any other situation where the loads supported at all attachment points for conductors are equals and all loads supported at attachment points for earth wires are equal too. Loads considered are:
 - Own weight of support.
 - Loads L_i , T_i and V_i equals in every attachment point for conductors.
 - Loads L_{ei} , T_{ei} and V_{ei} equals in every attachment point for earth wires.
- Load Case 3: In this case the load at one attachment point of conductors is different from the others. It is useful to represent the breaking of a conductor. Loads considered are:
 - Own weight of support.
 - Loads L_R , T_R and V_R in one of the attachment points for conductors (R), the most unfavorable for the strength of the support.
 - Loads L_i , T_i and V_i equals in all the rest of the attachment points for conductors different from R.
 - Loads L_{ei} , T_{ei} and V_{ei} equals in every attachment point for earth wire.
- Load Case 3F (break of conductor for a support with end of line function):
 - Own weight of support.
 - Loads L_R , T_R and V_R equals to zero in one of the conductors, the most unfavorable for the strength of the support.
 - Loads L_i , T_i and V_i equals in all the rest of the conductors different from conductor R.
 - Loads L_{ei} , T_{ei} and V_{ei} equals in every earth wire.
- Load Case 4 (break of earth wire): In this case the load at one attachment point of earth wires is different from the others. It is similar to Case 3 but represent the breaking of an earth wire instead of a conductor. Loads considered are:
 - Own weight of support.
 - Loads L_i , T_i and V_i equals in all the attachment point of conductors.

	GLOBAL STANDARD	Page 13 of 69
	LATTICE STEEL SUPPORTS FOR HIGH VOLTAGE LINES	GSCS001 Rev. 00 09/12/2020

- Loads L_{eR} , T_{eR} and V_{eR} in one of the attachment points for earth wires. The most unfavorable for the strength of the support in case that there are more than one earth wire.
- Loads L_{ei} , T_{ei} and V_{ei} equals in all the others attachment points for earth wires, in case there are more than one.
- Load Case 4F (break of earth wire for a support with end of line function):
 - Own weight of support.
 - Loads L_i , T_i and V_i equals in all the conductors.
 - Loads L_{eR} , T_{eR} and V_{eR} equals to zero in one of the earth wire. The most unfavorable for the strength of the support in case that there is more than one earth wire.
 - Loads L_{ei} , T_{ei} and V_{ei} equals in all the others earth wires, in case that there is more than one earth wire.
- Load Case 5: This case represents the characteristic strength of a support with a special function as derivation. Loads considered in this case are:
 - Own weight of support.
 - Wind pressure on the tower itself equal to 170 daN/m². (120 km/h)
 - Loads L_{iR} , T_{iR} and V_{iR} equals in every attachment point for conductors on the right side of the tower.
 - Loads L_{iL} , T_{iL} and V_{iL} equals in every attachment point for conductors on the left side of the tower.
 - Loads L_{eiR} , T_{eiR} and V_{eiR} for an earth wire on the right side of the tower.
 - Loads L_{eiL} , T_{eiL} and V_{eiL} for an earth wire on the left side of the tower.

5.5.3 Security coefficient

For every load case the security coefficient of one support is defined by the lower security coefficient of any element of this support, including angles, bolts, plates, etc...

The security coefficient of that element is defined as

$$CS = E_i / R_i$$

where

E_i is the value of the effect of actions (Load Cases), such as internal force or moment, or a representative vector of several internal forces or moments on the element

R_i is the corresponding structural resistance for that element.

5.5.4 Standard Strength

The standard strength of a support is defined by a set of minimum actions that must be able to resist for each load case with a defined security coefficient. So, every standard strength could be represented as a set of loading trees, where on every crossarm are acting the loads L_i , T_i and V_i and on every point of attachment of the earth wire are acting the loads L_{ei} , T_{ei} and V_{ei} defined on every load case.

The values of those actions and security coefficients are contemplated in the tables below.

Standard Strength	Load Case 1 and CS = 1,5					
	Load for every crossarm (daN)			Load for every earth wire (daN)		
	L_i	T_i	V_i	L_{ei}	T_{ei}	V_{ei}
L-0	-	264	250	-	251	220
L-1	-	531	500	-	366	435
L-2	-	620	1.212	-	415	497
L-3	-	1.490	1.715	-	1.103	1.612
M-0	-	820	600	-	599	528
M-1	-	1.100	1.120	-	748	706
M-2	-	1.300	1.290	-	1.105	1.187
M-3	-	1.600	1.855	-	1.104	1.762
M-4	-	1.810	3.735	-	1.104	2.092
G-1	-	2.485	1.100	-	1.988	1.001
G-2	-	2.930	1.290	-	2.491	1.187
G-3	-	3.460	1.365	-	2.491	1.269
G-5	-	4.080	2.850	-	2.489	2.109
G-6	-	6570	2780	-	2497	2113
F-1	2.698	382	857	2.374	378	754
F-2	3.826	589	1.002	2.372	530	902
F-3	3.877	1.013	1.895	2.404	932	1.800
F-4	3.575	3.000	1.520	1.788	1140	1.186
F-5	4.775	3.780	1.520	2.388	1021	1.186



Load Case 1 and CS = 1,875						
Standard Strength	Load for every crossarm (daN)			Load for every earth wire (daN)		
	Li	Ti	Vi	Lei	Tei	VeI
L-0	-	200	200	-	190	176
L-1	-	390	400	-	269	348
L-2	-	465	970	-	312	398
L-3	-	1.135	1.370	-	840	1.288
M-0	-	640	480	-	467	422
M-1	-	820	890	-	558	561
M-2	-	1.025	1.030	-	871	948
M-3	-	1.220	1.480	-	842	1.406
M-4	-	1.380	2.980	-	842	1.669
G-1	-	1.950	880	-	1.560	801
G-2	-	2.290	1.030	-	1.947	948
G-3	-	2.780	1.090	-	2.002	1.014
G-5	-	3.200	2.280	-	1.952	1.687
G-6	-	5140	2220	-	1957	1687
F-1	1.140	1.118	680	1.003	1.106	598
F-2	3.040	500	800	1.885	450	720
F-3	3.200	750	1.515	1.984	690	1.439
F-4	2.630	2.325	1.215	1.315	884	948
F-5	3.315	3.100	1.215	1.658	837	948

Load Case 2 and CS = 1,2						
Standard Strength	Load for every crossarm (daN)			Load for every earth wire (daN)		
	Li	Ti	Vi	Lei	Tei	VeI
L-0	330	-	250	1000	-	220
L-1	664	-	500	1069	-	435
L-2	775	-	1.212	1372	-	1091
L-3	1863	-	1.715	1379	-	1.612
M-0	1025	-	600	1005	-	528
M-1	1375	-	1.120	1375	-	1019
M-2	1625	-	1.290	1381	-	1.187
M-3	2000	-	1.855	1380	-	1.762
M-4	2263	-	3.735	1380	-	2.092
G-1	1328	1.779	1.100	1062	1.423	1.001
G-2	1565	2.097	1.290	1330	1.782	1.187
G-3	1848	2.477	1.365	1331	1.783	1.269
G-5	2180	2.920	2.850	1330	1.781	2.109
G-6	4.465	4110	2780	1.562	1562	2113
F-1	4.000	-	857	3.400	-	754
F-2	5.000	-	1.272	3.400	-	1.170
F-3	6.400	-	1.895	3.904	-	1.800
F-4	7.800	-	1.520	3.900	-	1.186
F-5	10.400	-	1.520	4.992	-	1.186



Load Case 3 and CS = 1,2						
Standard Strength	Load for broken conductor crossarm (daN)			Load for every earth wire (daN)		
	Li	Ti	Vi	Lei	Tei	VeI
L-0	1025	-	250	-	-	220
L-1	1375	-	500	-	-	435
L-2	1620	-	1.212	-	-	1091
L-3	1915	-	1.715	-	-	1.612
M-0	2050	-	600	-	-	528
M-1	2750	-	1.120	-	-	1019
M-2	3240	-	1.290	-	-	1.187
M-3	3975	-	1.855	-	-	1.762
M-4	4515	-	3.735	-	-	2.092
G-1	2654	711	1.100	-	569	1.001
G-2	3127	838	1.290	-	712	1.187
G-3	3696	990	1.365	-	713	1.269
G-5	4361	1.169	2.850	-	713	2.109
G-6	7.020	1880	2780	-	714	2113
F-1	5.000	-	857	-	-	754
F-2	6.000	-	1.272	-	-	1.170
F-3	7.500	-	1.895	-	-	1.800
F-4	9.600	-	1.520	-	-	1.186
F-5	12.000	-	1.520	-	-	1.186

Load Case 4 and CS = 1,2						
Standard Strength	Load for every crossarm (daN)			Load for broken earth wire (daN)		
	Li	Ti	Vi	Lei	Tei	VeI
L-0	-	-	250	2000	-	220
L-1	-	-	502	2135	-	437
L-2	-	-	1.211	2750	-	1090
L-3	-	-	1.718	2750	-	1.615
M-0	-	-	602	2000	-	530
M-1	-	-	1.121	2750	-	1020
M-2	-	-	1.293	2750	-	1.190
M-3	-	-	1.847	2750	-	1.755
M-4	-	-	3.768	2750	-	2.110
G-1	-	1.428	1.099	2132	571	1.000
G-2	-	1.653	1.293	2653	711	1.190
G-3	-	1.975	1.360	2653	711	1.265
G-5	-	2.294	2.851	2653	711	2.110
G-6	-	3742	2776	2.653	711	2110
F-1	-	-	860	3.900	-	757
F-2	-	-	1.273	3.900	-	1.171
F-3	-	-	1.889	3.900	-	1.795
F-4	-	-	1.538	3.900	-	1.200
F-5	-	-	1.538	3.900	-	1.200

Load Case 3 (End of Line Funtion) and CS = 1,2						
Standard Strength	Load for every crossarm (daN)			Load for every earth wire (daN)		
	Li	Ti	Vi	Lei	Tei	VeI
F-1	2.640	1.122	857	2.719	954	754
F-2	3.280	1.341	1.272	2.722	952	1.170
F-3	3.680	1.830	1.895	3.128	1.171	1.800
F-4	4.800	2.055	1.520	3.600	1.027	1.186
F-5	6.640	2.618	1.520	4.847	1.257	1.186

Load Case 4 (End of Line Funtion) and CS = 1,2						
Standard Strength	Load for every crossarm (daN)			Load for every earth wire (daN)		
	Li	Ti	Vi	Lei	Tei	VeI
F-1	2.400	1.600	857	2.328	800	754
F-2	3.000	1.923	1.272	2.340	865	1.170
F-3	3.840	2.378	1.895	2.342	1.094	1.800
F-4	3.900	3.633	1.520	1.950	690	1.186
F-5	5.200	4.825	1.520	2.496	676	1.186

5.5.5 Standard Graphs

Every set of load case and security coefficient can be represented on a graph that depicts on X-axis de representative longitudinal load and on Y-axis the representative transversal loads.

On that graph is depicted the line formed by every combination of loads L-T in which the security coefficient is that indicated on the graphic for a given representative vertical load.

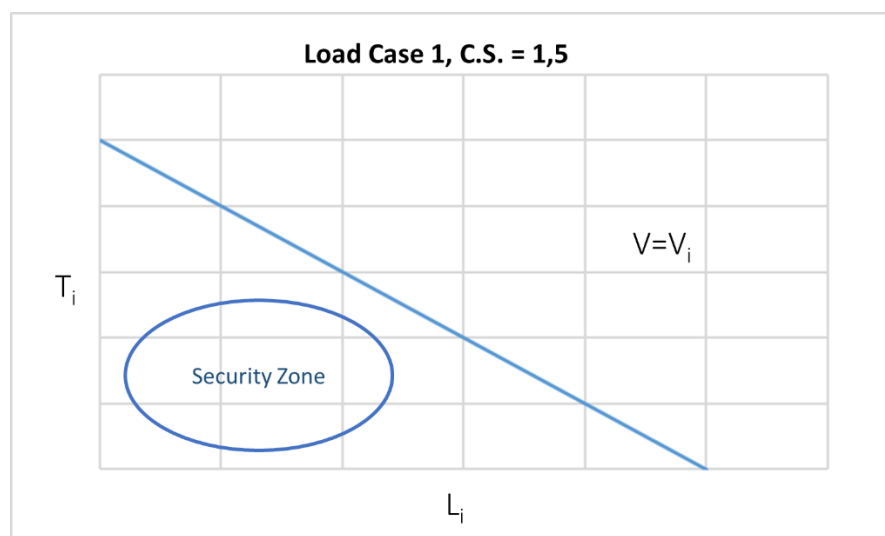

Example of standard graph.

	GLOBAL STANDARD	Page 18 of 69
	LATTICE STEEL SUPPORTS FOR HIGH VOLTAGE LINES	GSCS001 Rev. 00 09/12/2020

The area between the graphs axes and that line represents all the combinations of loads in which security coefficients of the tower is greater than that indicated, and then it is safe to use the support. The values indicated on the tables of paragraph 5.5.4 can be represented as a point in those graphs' lines.

For every load case it is defined a standard graphic where every point represents a combination of load of that case. All standard loads included in that load case, as indicated in paragraph 5.5.1, have to be related uniquely to representatives L and T, in a way that for every point in the graph all loads acting on the tower are known. For that purpose, for every standard graph there are defined coefficients to relate the loads on conductor to loads on earth wire. Those coefficients are α , β and λ , where:

$$L_{ea} = L_i \times \alpha$$

$$T_{ea} = T_i \times \beta$$

$$V_{ea} = V_i \times \lambda$$

Due to these graphs is possibly the use of combinations of L and T forces different from that indicated on the tables in paragraph 5.5.4.

For a tower to be assigned a standard strength, it is necessary to fulfil the requirements of security coefficients at any point of the line depicted in the standard graphs.

The standard graphs that match to every standard strength are included in Annex A.

5.6 Standard Clearances

5.6.1 Distance between phase conductors

The minimum distance between any attachment point of phase conductors and any other attachment point of conductor or earth wires shall be equal or greater than one of the Table 1 below.

Designation of the support will include this value of the table as indicated on paragraph

Distance between conductors (m)								
Designation value								
2,5	3,0	3,5	4,0	5,0	5,5	6,5	7,0	7,5
25	30	35	40	50	55	65	70	75

Table 1

	GLOBAL STANDARD	Page 19 of 69
	LATTICE STEEL SUPPORTS FOR HIGH VOLTAGE LINES	GSCS001 Rev. 00 09/12/2020

As an example, in Figure nº 1 it is depicted a support where distance between conductors is marked as D, E and F. In case a support it is designed with a distance between conductors of 40, then D, E and F shall be equal or greater than 4 m.

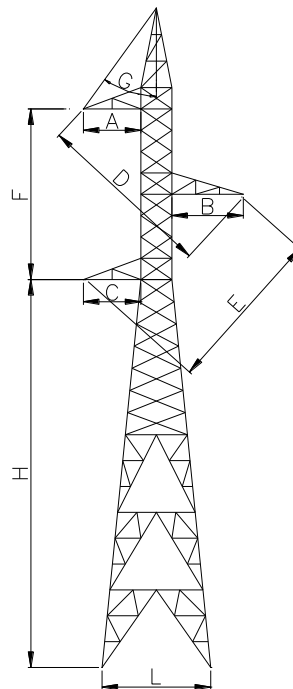

Figure nº 1

5.6.2 *Distance between phase conductors and earthed parts*

The minimum distance between any attachment point of phase conductors and any earthed parts of the support, apart from the cross-arm, shall be equal or greater than one of the indicated on Table 2.

The voltage indicated in the table is just an orientation. Designation of the support will include a value representative of that distance as indicated on paragraph 6.

Tower Type Group	Unified voltage values (kV)	Length of crossarm (m)	Designation Value
A	220	4,00	40
		3,50	35
B	150	2,60	26
	138		
	132	2,30	23
	115		
	110		
C	69	1,50	15
	66		
	45		

Table 2

As an example, in Figure n° 1 it is depicted a support where distance between conductors and earthed parts is marked as A, B and C. In case a support it is designed with a distance between conductors as 23, then A, B and C shall be equal or greater than 2,3 m.

5.7 Standard Height

The distance from the lower attachment point of phase conductors to the ground plane shall be equal to one of the included in the table below.

Standard height (m)									
10	12	15	18	21	24	27	31	35	39

Table 3

As an example, in Figure n° 1 it is depicted a support where standard height is marked as H.

5.8 Base Surface

The dimensions of the support at the ground level will not occupy any surface outside a square area of the length indicated at the table below.

Length at base support (m)										
Standard Height	10	12	15	18	21	24	27	31	35	39
One block foundation	2,25	2,34	2,46	2,59	2,71	2,84	2,96	3,13	3,3	3,46
Separate foundations	3,75	4,14	4,71	5,29	5,86	6,44	7,01	7,78	8,55	9,31

Table 4

	GLOBAL STANDARD	Page 21 of 69
	LATTICE STEEL SUPPORTS FOR HIGH VOLTAGE LINES	GSCS001 Rev. 00 09/12/2020

5.9 Attachment point of conductor and earth wire

Regardless the standard strength or the type of the support, it could always be used with any function of those indicated on paragraph 5.3. with suspension or tension insulation chains, regarding that all strength and dimensional needs of the line are met. For that aim, all the attachment point of conductor must allow the use of both type of insulation chains in a simple way.

At crossarms, the attachment point for conductor will be designed with three holes prepared for horizontal chains and an additional hole prepared for vertical chains.

The axis of the holes prepared for horizontal insulation chains will be perpendicular to the horizontal plane and the holes will be arranged forming a horizontal isosceles triangle with the base parallel to the direction of the line.

The axis of the hole prepared for vertical insulation chains shall be parallel to the direction of the line.

The diameter of these holes will be between 21.5 and 22 mm. unless another dimension is expressly specified.

As an example of this disposition for attachment point of conductor at crossarms is depicted Figure n° 2.

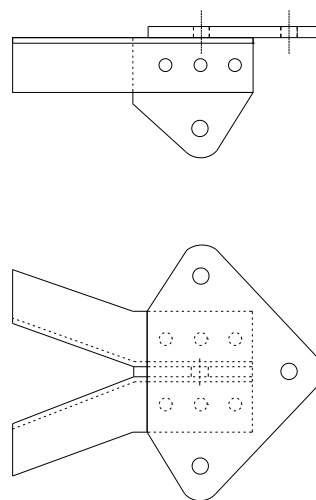

Figure n° 2: Example of point of attachment at crossarm

For earth wires it must be fulfilled the same purpose, and it must be allowed the attachment of the earth wire with tension or suspension function in an easy way.

Furthermore, in case of suspension function, the earth wire must be hold outside of the frame of the support, at one side of the support at least 20 cm away from it, or by means of a prefabricated hardware, as a C-block.

Examples of those dispositions for attachment point of earth wire are depicted on Figure n° 3 and Figure n° 4.

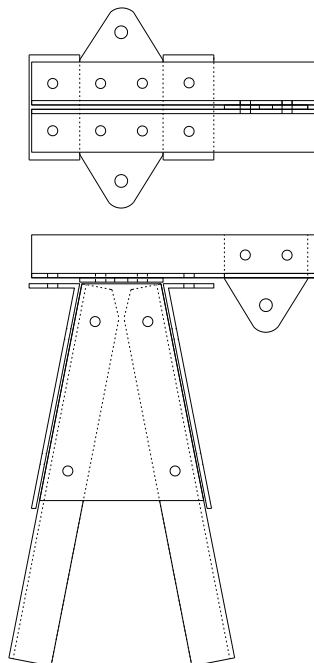

Figure nº 3: Example of point of attachment for earth wire

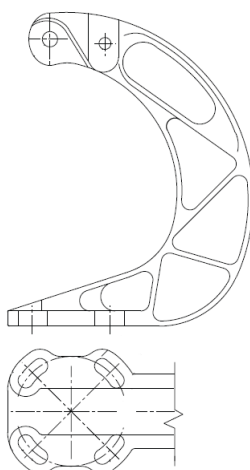

Figure nº 4: Example of C-block

At the mean angles of the support, near of the attachment point for the earth wire there must be an auxiliary hole for earthing purposes.

	GLOBAL STANDARD	Page 23 of 69
	LATTICE STEEL SUPPORTS FOR HIGH VOLTAGE LINES	GSCS001 Rev. 00 09/12/2020

5.10 Maintenance Facilities

Every part of the tower must be accessible for inspection and cleaning.

Lattice steel towers shall be provided with walkways for climbing and access equipped with technical devices for protection from falling such as rope protection systems, section rail systems, safety step bolts (e. g. pig tails) etc.

These walkways may consist of:

- Ladders;
- Step bolt arrangements;
- Stirrup arrangements.

If walkways are arranged at the leg members, they shall be provided at two opposite leg members.

Alternatively, the walkways with technical devices for protection from falling may be designed with one of the following:

- a single step bolt arrangement or a step ladder at tower faces perpendicularly to the line direction
- a ladder within the tower body

To provide protection against unauthorized climbing, these walkways should start around 2 m above ground level.

Step of any kind shall be rated for a concentrated load of 200 daN acting vertically at a structurally unfavorable position.

Unless otherwise specified, it is not necessary to provide any protection of the framework against unauthorized climbing.

6 DENOMINATION OF SUPPORTS

The denomination of one support will identify it with respect to the minimum efforts that it supports on every load case and its characteristic dimensions, and will consist of:

- A letter showing the number of circuits:
 - o S: one circuit (tree crossarms)
 - o D: two circuit (six crossarms)

- A letter followed by a slash and a number showing the standard strength indicated on paragraph 5.5.4 and 5.5.5:

Standard strength of supports			
Type L	Type M	Type G	Type F
L-0	M-0	G-1	F-1
L-1	M-1	G-2	F-2
L-2	M-2	G-3	F-3
L-3	M-3	G-5	F-4
	M-4	G-6	F-5

Table 5

According to the position and the function in the line, towers usually are selected as follows:

- Supports type L are used as alignment support with suspension function.
- Supports type M are used as alignment support with tension or anchorage function.
- Supports type G are used as angle support with anchorage function.
- Supports type F are used as alignment support with terminal function.

Nevertheless, any type of supports can be used as alignment or angle support with any function as long as the loads that need to resist are equals or lowers than those indicated for the standard strength in the relevant load cases.

- A three-letter code to show the disposition of the support as indicated in paragraph 5.2 and the table below:
 - : Tresbolillo.
 - : Doble bandera.
 - TRI: Triangle
 - CAP: Capa
 - HEX: Hexagon.
 - DAN: Danubio.
 - BAN: Bandera.
 - POR: Portico.
 - GAT: Cara de gato.

- The code MON, in case the foundations of the support are monolithic type, and then the base surface occupied by the support is that indicated in paragraph 5.8 for one block foundations

- A two-digit number followed by a hyphen indicating the separation distance between conductors in decimeters as indicated on paragraph 5.6.1.
 - 25: for a minimum distance between conductors of 2,50 m.
 - 30: for a minimum distance between conductors of 3 m.

	GLOBAL STANDARD	Page 25 of 69
	LATTICE STEEL SUPPORTS FOR HIGH VOLTAGE LINES	GSCS001 Rev. 00 09/12/2020

- 35: for a minimum distance between conductors of 3,5 m.
 - ...
 - 75: for a minimum distance between conductors of 7,50 m.
- A two-digit number followed indicating the clearance distance from conductors in decimeters as indicated on paragraph 5.6.2.
 - 15: for a minimum cross-arm length of 1,50 m.
 - 20: for a minimum cross-arm length of 2,00 m.
 - 23: for a minimum cross-arm length of 2,30 m.
 - 26: for a minimum cross-arm length of 2,60 m.
 - 35: for a minimum cross-arm length of 3,50 m.
 - 40: for a minimum cross-arm length of 4,00 m.
 - A two-digit number followed by the letter m to indicate the useful height of the support according to section 5.7:
 - 10 m.: for a standard height of 10 m.
 - ...
 - 39 m: for a standard height of 39 m.

The designation of the standardized support, an identification of the manufacturer and the year of manufacture must be engraved on the bottom of the uprights, approximately 1.5 m. over the ground level and visibly in an easy way.

6.1 Examples of denomination

DM-1 30-15 15m: Indicates a support for double circuit type M-1 with 3 m. of distance between conductors, crossarms of at least 1.5 m. in length, and a useful height of 15 m.

SG-3 MON 40-23 21m: Indicates a support for simple circuit, type G-3 with 4 m. of distance between conductors, crossarms of at least 2.3 m. in length, and a useful height of 21 m. The foundation is made of one block with a side smaller than 2,71 m.

SM-2 TRI MON 50-26 27m: Indicates a support for simple circuit with disposition of conductor type triangle, strength type M-2 with 5 m. of minimum distance between conductors, crossarms of at least 2.6 m. in length and a useful height of 27 m. The foundation is made of one block with a side smaller than 2,96 m.

6.2 Example of designation of support

For a designer of a line, it is needed to choose a support that carries one circuit and an earth wire with a disposition type triangle. For a load case including wind of $V_{b,0} = 26$ m/s the forces on the point of attachment due to conductor or earth wire (including wind forces on conductors) are:

- Longitudinal Load on every conductor, $L_i = 192$ daN
- Transversal Load on every conductor, $T_i = 854$ daN
- Vertical Load on every conductor, $V_i = 342$ daN
- Longitudinal Load on earth wire, $L_{ea} = 101$ daN
- Transversal Load on earth wire, $T_{ea} = 450$ daN
- Vertical Load on earth wire, $V_{ea} = 132$ daN

Those forces need to be resisted by the chosen tower with a security coefficient equal or greater than 1,5

The distance required between phases on the tower is 3,38 m

The length required for the crossarm, from the point of attachment of conductors to the tower body is 2,12 m

The height required from the point of attachment of the lower conductor to ground is 21 m.

It is required a compact foundation in one block.

The standard tower that fulfill all those requirements is the following:

- As a single circuit denomination will start with a letter **S**
- Strength is decided from graphic of Load Case 1 with $CS=1,5$

Representing the point of the tower on the graphic it is needed to choose one type that is over it. In this case is type **M-1**.

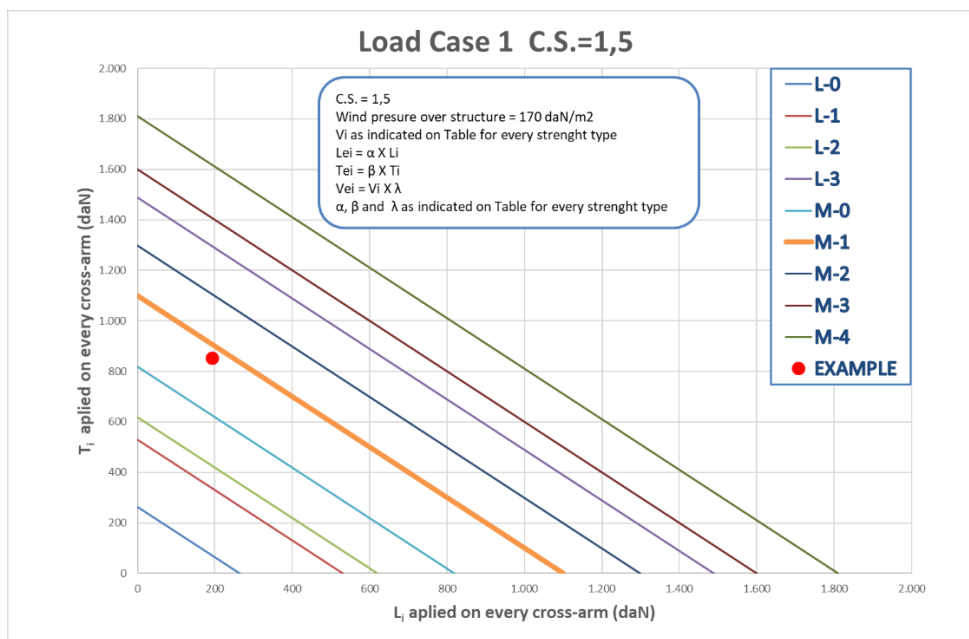

	GLOBAL STANDARD	Page 27 of 69
	LATTICE STEEL SUPPORTS FOR HIGH VOLTAGE LINES	GSCS001 Rev. 00 09/12/2020

Once chosen type M-1, it has to be checked that vertical load of conductors and loads on earth wire are lower than those of the graphic.

For a type M-1, the range of vertical loads supported by every conductor within the security coefficients allowed is 0 to 1.120 daN, The example load $V_i = 342$ daN is included, so it is valid.

The loads of earth wires in a graphic are related to loads on conductors by the following coefficients:

Case Load 1	α	β	λ
M-1	0,68	0,68	0,63

So, load resisted on earth wire by a type M-1 in the point of work of the example are:

$$L_{ea} = L_i \times \alpha = 192 \times 0.68 = 131 \text{ daN}$$

$$T_{ea} = T_i \times \beta = 854 \times 0.68 = 581 \text{ daN}$$

$$V_{ea} = V_i \times \lambda = 342 \times 0.63 = 216 \text{ daN}$$

And comparing with the load required it is concluded that Type M-1 resist the loads required on conductors and earth wire with a security coefficient greater than 1.5.

	Load for M-1	Load required	Check
L_i	192	192	OK
T_i	854	854	OK
V_i	0 to 1.120	342	OK
L_{ea}	131	101	OK
T_{ea}	581	450	OK
V_{ea}	216	132	OK

- It is required disposition Triangle, then denomination continue with **TRI**
- It is required one block foundation, then denomination continue with **MON**
- It is required a minimum distance between conductors of 3.38, so it is used the immediate superior standard distance defined on paragraph 5.6.1, that is 4 m and indicated in denomination as **40**
- It is required a minimum length of crossarms of 2.12, so it is used the immediate superior standard distance defined on paragraph 5.6.25.6.1, that is 2,3 m and indicated in denomination as **23**
- It is required a height of 21 m, then denomination finish with **21m**

Eventually the standard denomination of the tower that fulfill all those requirements is the following:

SM-1 TRI MON 40-23 21m

	GLOBAL STANDARD	Page 28 of 69
	LATTICE STEEL SUPPORTS FOR HIGH VOLTAGE LINES	GSCS001 Rev. 00 09/12/2020

7 CONSTRUCTION CHARACTERISTICS

7.1 General Characteristics

7.2 Materials

Angles and plaques:

In general, only the structural steel grades S235J0 and S235J2 as well as S355J0 and S355J2 according to EN 10025-1:2005 02 and EN 10025 2:2005 04 may be used.

It is also possible the use of equal-sided angle profiles and high-strength, normal steel plates in accordance with ASTM A-36 for normal steel, and ASTM A572 grade 50 for high-strength steel.

Nevertheless, it is not possible the use of steel according to EN standards and ASTM standards simultaneously on the same tower.

The minimum thickness allowed for profiles will be 6 mm for the uprights and cross members elements, and 4 mm for the other elements.

The thickness of joint plates will be equal or greater than those of the profiles that are jointed, with a minimum of 6 mm.

If weakened by boreholes, angle sections with a width below 40 mm are inadmissible. In case there is admitted the use of welded angles, the minimum width for those angles will be 35 mm.

Profiles less than 60mm x 60mm x 6mm will not be used for studs and cross members.

Bolts:

According to ASTM A394 or EN-ISO 898-1

In general, only the strength qualities 5.6 and 8.8 shall be used.

It should be considered that the fixing of the bolts will be with nut and jam nut.

The minimum bolt diameter will be 16 mm for the uprights and 12 mm for the other elements.

7.3 Welding

Welding operations shall be in accordance with EN 1090-1.

Special care shall be taken to ensure proper galvanizing.

Welded angles shall only be used with previous consent of Enel for the specified tower.

In any case, welding on site it is not allowed.

7.4 Connections

The connections between profiles will be designed in such a way that their axes are at the same point, minimizing the eccentricities.

The joints between the elements of the tower structure will be made usually by bolts and nuts, also using joint plates or connection profiles where necessary.

	GLOBAL STANDARD	Page 29 of 69
	LATTICE STEEL SUPPORTS FOR HIGH VOLTAGE LINES	GSCS001 Rev. 00 09/12/2020

Bolted connections shall be secured against loosening. This can be achieved by an adequate tightening of the nuts. Spring washers may be used as an indication for enough tightening

It is not allowed the use of punching methods for holes on angles or plates with thickness greater than 10 mm. Nevertheless, drills can be punched to a diameter smaller than the final diameter.

Structural members of crossarms permanently loaded in tension shall not be punched.

Any kind of perforation by drilling or punching on site it is not allowed.

Strength calculation and geometry design of connections will follow the recommended rules indicated on EN 1933-1-8 "Eurocode 3: Design of steel structures - Part 1-8: Design of joints" or ASCE 10-15 "Design of Latticed Steel Transmission Structures" with special attention to edge and borehole distances. In any other case, connections resistance will be checked by test or justified by specific calculations.

7.5 Anchor Stub

Unless otherwise specified, stubs are to be supplied for their use in concrete foundations.

The stubs will come with holes to install the cleats at the assembly stage. The stub provision includes cleats and their bolts.

The two transversal dimensions of the stub will always be greater than the connection amount.

For grounding, holes will be made 60 cm below ground level.

At least four (4) holes will be supplied for javelin installation per tower.

7.6 Corrosion protection

All metal parts, bolts, nuts and washers will be hot dip galvanized according to the recommendations indicated in ISO 1461:2010 or ASTM A123.

The galvanizing must be uniform, free of lumps and bubbles, with good adhesion, so as to allow proper assembly of the different components.

The thickness of the zinc coating shall not be less than 78 μm on any point, with a mean value greater than 86 μm on every element. The mass of the zinc coating shall not be less than 610 g / m^2 .

When specifically asked, a coat of anticorrosive paint will be applied to all the elements of the tower before dispatching them from the workshops. It will be of such a structure that mechanically and chemically protects the galvanized coating and that it does not come off easily.

8 TESTING

8.1 Factory acceptance tests

For the inspection, the material corresponding to the order or batch will be stored by type of support and number in a specific and easily accessible area.

	GLOBAL STANDARD	Page 30 of 69
	LATTICE STEEL SUPPORTS FOR HIGH VOLTAGE LINES	GSCS001 Rev. 00 09/12/2020

It will be checked that all the material has been properly packed and protected to prevent damage and loss during transport, that every package has been correctly labeled and that all packages included in the order or batch have been presented to inspection.

From all those packages there will be selected a group to be tested, formed by all the packages from 5 %, rounded up, of the towers forming the batch.

The acceptance test for that group of packages are the following.

8.1.1 Visual inspection

Verification that the content of all the packages of bars and joint plates and 10% of the packages of bolts correspond to that listed on the packing list. Checking that the individual components are complete with the markings provided and that those markings are clearly legible. Specifically, it will be verified that the standard denomination of the support and the year of manufacture are visibly engraved on the lower part of the uprights, and that this mark appears on the drawings of the support.

Furthermore, it should be checked that there are no defects of processing, that the materials do not have lamination defects, and they are free from local, flexural and torsional deformations and that the holes do not present tapering due to the use of worn punches.

8.1.2 Dimensional verification

A dimensional check of 5% of angles, 5% of joint plates and 5% of bolts used for visual inspection will be carried out. That pieces will be selected, if possible, ensuring that the pieces are different from each other.

It must be checked that all dimensions correspond to those shown in the construction drawings

The tolerances for those measurements are as follows:

- | | |
|---|-----------|
| ○ total dimension of the piece: | 1 mm / m |
| ○ hole centers from different groups: | 1 mm / m |
| ○ hole centers from the same group: | 0.7 mm |
| ○ profiles gravity center: | 0.7 mm |
| ○ displacement of one face with respect to the other: | 0.7 mm |
| ○ hole's diameters: | -0; + 3mm |
| ○ straightening of main bars: | 2/1000 |
| ○ straightening of lattices and secondary bars: | 1/1000 |

8.1.3 Galvanization verification

On every sample used for dimensional verification, it will be verified the quality and the thickness of the galvanizing using the magnetic method.

	GLOBAL STANDARD	Page 31 of 69
	LATTICE STEEL SUPPORTS FOR HIGH VOLTAGE LINES	GSCS001 Rev. 00 09/12/2020

8.1.4 Inspection of welds

On every sample used for dimensional verification, welds will also be visually inspected. Inspector has the possibility to ask for scrape and inspection by penetrating liquids of the pieces that are considered appropriate.

8.1.5 Material properties verification

It must be checked that the materials used correspond to those prescribed in construction drawings. For this purpose, there must be provided the certificates of origin of the materials used. Then, tensile and resilience tests will have to be carried out on samples from two angles and two plates. And tensile test on samples from two bolts.

8.1.6 Weight verification

Verification that the total weight of every package selected for acceptance tests is greater than 98% of the theoretical weight indicated in the support reference documentation.

For every test, in case of failure on more than one sample the batch must be rejected.

In case of failure on one sample, there will be selected a new group of samples to be tested doubled than the initial one, if any of these new samples fail, the batch must be rejected.

8.2 Type test

Towers design must be validated by mean of tests to check their strength.

Tests shall be performed on a full-sized prototype of the structure and/or components of the structure.

Reference standard for those tests is EN 60652:2004 "Loading test on overhead line structures" or Chapter 6 from ASCE 10-95 "Design of latticed steel transmission structures".

The prototype to be tested must have successfully passed all the factory acceptance tests indicated on paragraph 8.1

A test is completed successfully when 100% of nominal loads are applied for a time longer than a minute without failure and there are not local plastic deformations such as bowing or warping on any element.

Enel could choose to accept a tower design not validated by a full-sized prototype test, as long as it have the stress coefficients of all the elements as a function of their own weight, wind on the structure and unit loads applied in three dimensions at all the connection points of the conductor and ground cable or all the information necessary to be able to obtain these coefficients by means of commonly used calculation programs. This information includes, among others, the following data:

- Complete description of the support and foundation geometry.
- Geometry of the lines of axes of the bars or "wire model", or scheme.
- Complete description of each of the profiles used, including:

	GLOBAL STANDARD	Page 32 of 69
	LATTICE STEEL SUPPORTS FOR HIGH VOLTAGE LINES	GSCS001 Rev. 00 09/12/2020

- Catalog and section
- Type of steel
- Length
- Complete description of all joints including the number, diameter and location of the bolts and holes used as well as characteristics of the gussets, linings or welds used.

In addition, in these cases, a first support or prototype will be assembled with all its parts that will be visually inspected in search of possible defects, checking that all the parts assemble perfectly without the need to use a reamer and a photographic report of the assembly of the prototype will be issued.

9 SUPPLY REQUIREMENTS

The material supply of the different elements must consider a series of attentions intended to eliminate any type of error in the identification and ultimately facilitate the assembly and erection of the tower.

Thus, on the one hand, the identification of elements and modes of assembly must be unambiguous so that they can always be verified, before and after assembly. In particular, the following specifications should be considered:

- The identification of the supports, especially in the uprights and at least one of them in a stamped shape, will consist of: the supplier's logo, the denomination of the support according to this standard and the year of manufacture
- All loose elements must be indelibly marked and identified for assembly with a number and support to which it is intended.
- The bolts will be engraved with the manufacturer's mark and quality.

9.1 Packing

Regarding the shipping method and its preparation for assembly, the following indications should be considered:

- The components of a support must be packed with straps and forming a minimum number of packages, manageable in transport and on site.
- These packages will be identified with a label to embrace it by the strap and identified with the following elements:
 - Specific identification in reference to the line and project.
 - Identification of the support on the line (support number).
 - Provider
 - Type of support, nominal tension, height and distance between conductors.
 - Destination address
 - Name of the package (upper cross, 1st section, etc.)

	GLOBAL STANDARD	Page 33 of 69
	LATTICE STEEL SUPPORTS FOR HIGH VOLTAGE LINES	GSCS001 Rev. 00 09/12/2020

- Package number and total number of packages (as an example: 1/5, 2/5, etc.)
- Each package will be accompanied by its list of materials.
- With every support, its assembly drawing will be supplied.
- Loose elements such as bolts, nuts, washers, bushings, plates, etc., must be supplied in suitable boxes, with the identification indicated above. Bolts will be supplied grouped by measure, identifying each of the different groups.

10 DOCUMENTATION

The following list indicates the minimum technical information that suppliers shall provide for every tower.

- Layout drawings with indication of profiles, bolts, principal dimensions and total weight of the tower.
- Detailed drawings for erection.
- Bill of material with indication of elements marks, weights, section profiles and materials.
- Packing list, including bolts with indication of lengths.
- Information and drawings for foundations.
- Standard graphs, or equivalent, showing real strength of the tower and utilization limits.
- Representation BIM for each tower.

	GLOBAL STANDARD	Page 34 of 69
	LATTICE STEEL SUPPORTS FOR HIGH VOLTAGE LINES	GSCS001 Rev. 00 09/12/2020

LOCAL SECTION A – Enel Distribución Colombia

	GLOBAL STANDARD	Page 35 of 69
	LATTICE STEEL SUPPORTS FOR HIGH VOLTAGE LINES	GSCS001 Rev. 00 09/12/2020

LOCAL SECTION B – Enel distribución Perú

B1. Design, Normal Height and Leg Extension

The manufacturer must consider a body extension +6 and the maximum leg of +2 for the design of the structures (Most critical combination)

The normal height from the level of the crosshead below ground level is $h \pm 0$ is 15 m for a suspension tower and 13 m for angle towers.

The lower part of each type of tower must be designed in such a way that its height can be easily varied by fixed sections of 3 m, up to maximum variations of minus three (-3) to plus six (+ 6) meters with respect to the normal height, without the need to modify the upper part of the tower.

Furthermore, to adapt to the asymmetric profile of the terrain, the height of each leg of any type of tower and extension must be easily varied, independently of the others, by fixed sections of one (1) meter, from minus one (-2) meter plus three (+ 3) meters.

B2. Standards

In addition to the standards indicated in 3.2, consider the following:

ASTM A36	Perfiles y placas de acero estructural.
ASTM A572-Grado 50	Perfiles y placas de acero de alta resistencia.
ASTM A6	Requerimientos para el suministro de perfiles y placas de acero.
ASTM A394	Pernos y tuercas galvanizados.
ANSI B18.21.1	Arandelas de presión.
ANSI B18.2.1	Pernos hexagonales y roscas.
ANSI B18.2.2	Tuercas hexagonales.
ASTM A123	Galvanización de perfiles.
ASTM A153	Galvanización de ferreterías, pernos, tuercas y arandelas.
ASTM B201	Cromatización de piezas galvanizadas.
ASCE No. 52	Guide for Design of Steel Transmission Towers.
IEC 60652	Loading Test on Overhead Line Structures.
CNE	Código Nacional de Electricidad (Suministro 2011)

B3. DISEGN CRITERIA AND CALCULATION

B3.1 Distance between phase conductors and earthed parts

220kV:

- **Minimum** vertical distance between conductors: 6,5 m
- **Minimum** distance between conductors and earthed parts: 2,50 m

	GLOBAL STANDARD	Page 36 of 69
	LATTICE STEEL SUPPORTS FOR HIGH VOLTAGE LINES	GSCS001 Rev. 00 09/12/2020

60kV:

- **Minimum** vertical distance between conductors: 3,5 m
- **Minimum** distance between conductors and earthed parts: 1,00 m

B3.2 Load cases

In addition to what is indicated in 5.5.2, the following criteria must be considered for the design and calculation of the elements of the tower structure:

Service load

Under conditions of service loads, it will be admitted that the tower is subject to the simultaneous action of the following:

- **Vertical loads**
The weight of conductors, insulators, accessories, guard wire, tower and a man's weight.
- **Horizontal loads**
 - Wind pressure, over the total projected area.

The wind load on the tower structure will be verified as indicated in the CNE code

$$W = 3,2 \cdot q \cdot A$$

Where:

- W = Is the total wind load (daN)
- q = Is the wind pressure, (daN/m²)
- A = Is the total surface exposed to the wind (m²)

- The horizontal component of the maximum conductor and guard wire load determined relative to the maximum deflection angle.

- **Longitudinal loads**

	GLOBAL STANDARD	Page 37 of 69
	LATTICE STEEL SUPPORTS FOR HIGH VOLTAGE LINES	GSCS001 Rev. 00 09/12/2020

The longitudinal horizontal component of the maximum working load of the conductor and the guard wire.

- **Assembly and Maintenance Loads**

The additional loads that affect the tower during assembly and maintenance tasks due to personnel and maneuvering equipment.

Loads of break of one conductor and break of earth wire

Load condition where the tower is subject, in addition to normal loads to a horizontal force, corresponding to the breakage of a conductor.

This load will have the following value:

- For terminal towers: 100% of the maximum conductor load.
- For terminal towers: 100% of the maximum earth wire load.

This load will be determined in its longitudinal and transverse components, according to the corresponding deviation angle.

The own weight and the wind loads corresponding to the broken conductor will be considered as acting in the middle of the corresponding span.

B3.3 Calculation Criteria

Overload factors

The grade C overload factor, indicated in the CNE code (Table 253-1), the relationship between the stress of each element of the tower structure and the maximum stress on the same element calculated by the most unfavorable load condition

Under normal conditions:

Transverse wind loads	2,2
Transverse tension loads	1,3
Vertical loads	1,5
Longitudinal loads	1,3

When a tower is subjected to a load corresponding to any of the indicated conditions multiplied by the corresponding overload factor, no permanent deformation or failure shall occur.

Limit Efforts

	GLOBAL STANDARD	Page 38 of 69
	LATTICE STEEL SUPPORTS FOR HIGH VOLTAGE LINES	GSCS001 Rev. 00 09/12/2020

The limit stress of each element of the tower structure will be:

- For tensile stresses: The elastic limit of steel.
- For compression stresses: The buckling limit stress.

Buckling Calculation Method

The buckling limit stress is obtained by the following formula:

$$S = \frac{F}{k}$$

Where:

- S = It is the buckling limit stress (daN/mm².)
- F = It is the elastic limit of steel (daN/mm².)
- k = Buckling number determined according to the slenderness ratio of each element and calculated according to a method presented by the Contractor and approved by the Supervisor.

Slenderness ratio (Γ)

The slenderness ratio (Γ) of a compression element is the ratio between its equivalent buckling length (L) and its minimum turning radius (R).

L : In general, the equivalent buckling length to be considered is the distance between the effectively subject points located in the considered buckling plane. However, when the element is not only subject, but its rotation is impeded at both ends, the effective length to be considered can be 8/10 of the length between the subject points.

R : In general, the turning radius to be considered is the minimum radius of the section. However, when it is certain that there will be buckling in a plane parallel to that of a profile, the turning radius corresponding to such a plane can be considered.

In the case of an element in cross compression and joined to another element in tension, the point of union can be considered as a fixed point in a direction perpendicular to the plane determined by the two elements, provided that the stresses in both elements are approximately equal in magnitude and the union at the point is adequate.

The slenderness ratio of elements to compression shall not exceed the following limits:

- For studs and crosspieces : 150
- For braces, diagonals and other elements : 200
- For redundant elements : 250

Calculation method

	GLOBAL STANDARD	Page 39 of 69
	LATTICE STEEL SUPPORTS FOR HIGH VOLTAGE LINES	GSCS001 Rev. 00 09/12/2020

The calculation method to be followed will be the latest edition of the Transmission Tower Design Guide for the ASCE - American Society of Civil Engineers.

Overlapping Loads

The effect of earthquakes on structures should consider the following accelerations:

- Vertical : 0,3 g
- Horizontal : 0,5 g

The resulting horizontal and vertical forces should be applied before considering the overload factor for exceptional loads (F.S = 1.3.) And in windless conditions.

Particular Design Criteria

In the design of the tower structures, efforts will be made to minimize the number of elements, as well as variety.

The connections between profiles will be designed in such a way that their axes are at the same point, minimizing the eccentricities.

The joints between the elements of the tower structure will be made by bolts and nuts necessary, also using joint plates where necessary. Welds between profiles will not be accepted. All elements of the towers must be assembled with two minimum bolts. The towers will be designed so that all parts are accessible for inspection and cleaning. Pockets or depressions that could store water should have drainage holes.

In the design of the tower, it should be considered that the assembly of the profiles should be downstream and the lateral profiles towards the interior of the tower.

The joints must be able to develop the maximum efforts of the members.

By using connection profiles, the angular edge of the inner profile will be rounded so that it does not interfere with the curvature of the profiles of the structure.

It should be considered that the fixing of the bolts will be with nut and jam nut.

Loads Tree

The values considered for the load tree are shown below:

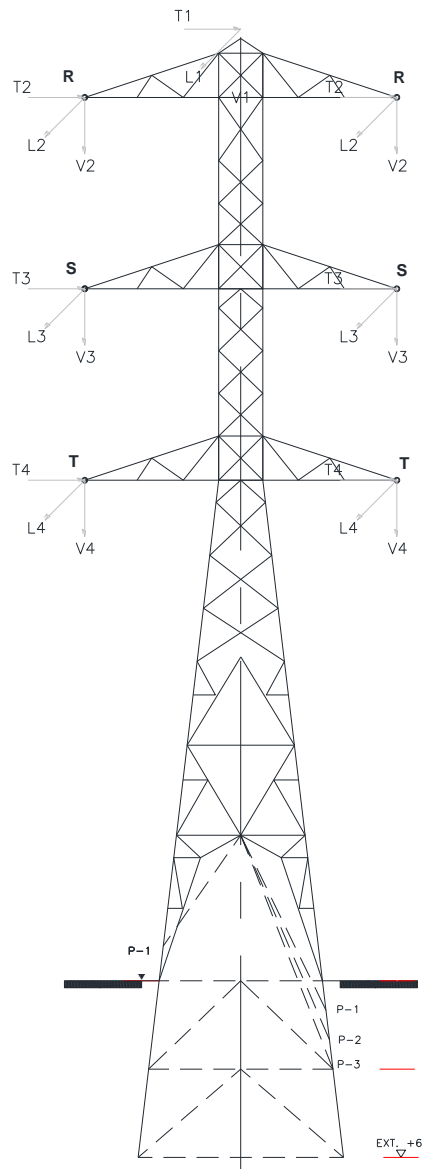

Anchor Stub

The stubs to be supplied will be used in reinforced concrete foundations, for whose design and calculation the maximum loads transmitted by the tower at ground level and concrete of 175 kg / cm² will be used. The load values will be those that result from the structural calculation program of the tower. The stubs will come with holes to install the cleats at the assembly stage. The stub provision includes cleats and their bolts.

The two transversal dimensions of the stub will always be greater than the connection amount. The minimum length is 3.5m.

For grounding, holes will be made 60 cm below ground level.

At least four (4) holes will be supplied for javelin installation per tower.

	GLOBAL STANDARD	Page 41 of 69
	LATTICE STEEL SUPPORTS FOR HIGH VOLTAGE LINES	GSCS001 Rev. 00 09/12/2020

Maximum deflection

The maximum allowable deflection will be 1.5% of the tower free height, when 100% of the work loads are applied without overload factors.

B4. CONSTRUCTIVE PRESCRIPTIONS

Material

Equal-sided angle profiles and high-strength, normal steel plates shall be used for tower structures, in accordance with ASTM A-36 for normal steel, and ASTM A572 grade 50 for high-strength steel or its The standard DIN 17100 or its equivalents is defective, with the following minimum characteristics:

Characteristics	Normal Steel	High Strength Steel
	A 36	A572
Breaking effort (daN/mm ²)	37-45	52-62
Elastic limit (daN/mm ²)	25	36
Elongation at break ($L_0 = 5d_0$)	25%	22%

Minimum Sizes

The minimum thickness allowed for profiles and plates will be 6 mm for the uprights and cross members elements, and 4 mm for the other elements.

Profiles less than 60mm x 60mm x 6mm will not be used for studs and cross members, and 35mm x 35mm x 4mm for all other members. The minimum bolt diameter will be 16 mm (5/8") for the uprights and 12 mm (1/2") for the other elements.

The minimum distances and plates to the drilled or punched holes will be the following:

DIAMETER OF CAP SCREW mm (pulgada)	Minimum distance mm (pulgada)	
	FOR CUTTING EDGES	FOR FLYED OR GAS CUTTING EDGES
12 (1/2")	20 (7/8")	16 (3/4")
14 (9/16")	35 (1 1/8")	20 (7/8")
16 (5/8")	70 (1 1/4")	25 (1")
20 (3/4")	80 (1 1/2")	35 (1 1/8")

	GLOBAL STANDARD	Page 42 of 69
	LATTICE STEEL SUPPORTS FOR HIGH VOLTAGE LINES	GSCS001 Rev. 00 09/12/2020

25 (1")	100 (13/4")	70 (11/4")
-----------	-------------	------------

All distances in this column may be reduced by 1/8 "when the hole is at a point where the stress does not exceed 25% of the maximum allowable stress of the element.

The minimum distance between the hole centers should not be less than 2 2/3 times the nominal diameter of the bolt, but preferably not less than 3 diameters.

Cut

During manufacturing, the profiles, the reinforcement plates and covers them together, etc. they will be cut with a guide and they can be cut or sawn and all metal burrs will be carefully removed. All profiles, reinforcements and joint covers, etc. they will be perfectly straight.

Bent

Profiles and reinforcing plates that need to be bent will be hot bent. Where for particular reasons the elements are cold bent, the material will be subsequently collected or relieved of tensions.

Perforations

The structural elements will have all of their perforations made in the shop, so no drilling is required on site to add any extension elements to the towers.

The distance from the center of the bolt holes to the edge of each steel section shall not be less than 1.5 times the bolt diameter.

In addition, the minimum distance between the centers of the holes for adjacent bolts shall not be less than 2.5 times the diameter of the corresponding bolt.

Drills can be punched to a diameter three millimeters smaller than the final diameter or drilled to a diameter one millimeter smaller than the final diameter, if the quality of the steel and the experience of the manufacturer to punch and strip and galvanize are such that they do not verify no danger of breakage.

The final appearance of the perforations should be circular, without burrs or cracks.

Tolerances

The maximum admissible tolerance in the cut of the pieces will be 1 per thousand.

The maximum allowable difference between the diameter of the hole and the diameter of the bolt shall not exceed 1 mm.

The maximum permissible tolerances in the mutual position of the holes will be as follows:

- At the same end of the profile : ± 0,5 mm.
- Between opposite ends of the profile : ± 1 mm.

	GLOBAL STANDARD	Page 43 of 69
	LATTICE STEEL SUPPORTS FOR HIGH VOLTAGE LINES	GSCS001 Rev. 00 09/12/2020

No tolerance will be allowed in the position of the axis of the perforations with respect to the axis of the profile.

Joints

The upright joints will preferably be of the stop type, however, overlay joints may be used with prior approval.

The corners of the profiles will be opportunely chamfered in order to ensure direct and continuous contact between the walls of the profiles. The minimum length of the joints will be at least 300 mm with a minimum of 6 bolts.

Marked

All elements of the structures for the different types of towers will be marked.

Pieces to be embedded

Parts intended to be embedded in foundation concrete will have adequate devices to increase adhesion between steel and concrete.

Galvanization

All metal parts, bolts, nuts and washers will be galvanized according to the recommendations indicated in ASTM A123, A 153 and A394.

The galvanizing must be uniform, free of lumps and bubbles, with good adhesion, so as to allow proper assembly of the different components.

The thickness of the zinc coating shall not be less than 600 g / m² for the elements of the exposed metal structure and not less than 800 g / m² for the buried elements.

To all the elements of the tower, a coat of anticorrosive paint will be applied before dispatching them from the workshops. It will be of such a structure that it mechanically and chemically protects the galvanizing and that it does not come off very easily.

	GLOBAL STANDARD	Page 44 of 69
	LATTICE STEEL SUPPORTS FOR HIGH VOLTAGE LINES	GSCS001 Rev. 00 09/12/2020

LOCAL SECTION C – Enel distribución Chile

	GLOBAL STANDARD	Page 45 of 69
	LATTICE STEEL SUPPORTS FOR HIGH VOLTAGE LINES	GSCS001 Rev. 00 09/12/2020

LOCAL SECTION D – Enel Distribuição Rio, Goiás and São Paulo

3.3 Local Standards

- NBR5422- PROJETO DE LINHAS .AÉREAS DE TRANSMISSÃO DE ENERGIA ELÉTRICA
- NBR5426 - Planos de amostragem e procedimentos na inspeção por atributos.
- NBR5909 - Cordoalhas de fios de aço zincados para estais, tirantes, cabos mensageiros e uso similares.
- NBR6153 - Produto metálico - Ensaio de dobramento semi-guiado.
- NBR6323 - Galvanização de produtos de aço ou ferro fundido - especificação.
- NBR7397 - Produto de aço ou ferro fundido revestido por zinco por imersão a quente - determinação da massa do revestimento por unidade de área - método de ensaio.
- NBR7398 - Produto de aço ou ferro fundido galvanizado por imersão a quente – verificação da aderência do revestimento - método de ensaio.
- NBR7399 - Produto de aço ou ferro fundido galvanizado por imersão a quente – verificação da espessura do revestimento por processo não destrutivo – método de ensaio.
- NBR7400 - Galvanização de produtos de aço ou ferro fundido por imersão a quente – verificação da uniformidade do revestimento - método de ensaio.
- NBR8842 - Suportes metálicos treliçados para linhas de transmissão – resistência ao carregamento.
- NBR8851 - Parafuso sextavado para uso estrutural – dimensões.
- NBR8852 - Porca sextavada - acabamento grosso - características e dimensões - padronização.
- NBR8853 - Porta sextavada de segurança para estruturas metálicas de linhas de transmissão e subestações.
- NBR8855 - Propriedades mecânicas de elementos de fixação – parafusos e prisioneiros – fixação.
- ASTM A36/A36M - Standard specification for carbon structural steel.
- ASTM A143 - Standard practice for safeguarding against embrittlement of hot-dip galvanized structural steel products and procedure for detecting embrittlement.
- ASTM A275 - Standard practice for magnetic particle examination of steel forgings.
- ASTM A370 - Standard test methods and definitions for mechanical testing of steel products.
- ASTM A668/A668M - Standard specification for steel forgings, carbon and alloy, for general industrial use.
- ASTM A711/A711M - Standard specification for steel forgings stock.

	GLOBAL STANDARD	Page 46 of 69
	LATTICE STEEL SUPPORTS FOR HIGH VOLTAGE LINES	GSCS001 Rev. 00 09/12/2020

LOCAL SECTION E – e-distribuzione

	GLOBAL STANDARD	Page 47 of 69
	LATTICE STEEL SUPPORTS FOR HIGH VOLTAGE LINES	GSCS001 Rev. 00 09/12/2020

LOCAL SECTION F – Edistribución Redes Digitales

	GLOBAL STANDARD	Page 48 of 69
	LATTICE STEEL SUPPORTS FOR HIGH VOLTAGE LINES	GSCS001 Rev. 00 09/12/2020

LOCAL SECTION G – e-distribuție Banat, Dobrogea and Muntenia

For towers with separate foundation and a standard height of 24 m. the dimensions at the ground level could be greater than that indicated on paragraph 5.8, as long as they will not occupy any surface outside a square area of 7.5 m length.

1. Local Standards

SR EN 50341-2-24 – Linii electrice aerine de tensiune alternativă mai mare de 1kV. Partea 2-24. Aspectele normativelor nationale (NNA) pentru Romania (pe baza EN 50341-1:2012)

NTE 003/04/00 – Normativ pentru construcția liniilor electrice aeriene de energie electrică cu tensiuni peste 1000V

2. Design conditions

2.1 Climate-meteorological factors

The lattice steel is directly subject to the action of the meteorological factors whose intensity is given in the standard SR EN 50341-2-24 Aerial electric lines with an alternative voltage greater than 1 kV Part 2-24: Aspects of the national norms (NNA) for Romania (based on EN 50341-1: 2012)

Meteorological weather factors that are considered when calculating and dimensioning the components of overhead power lines.

Temperatures (°C)

- a) minimum temperature, -30°C (wind and ice loads are missing);
- b) average temperature, 15°C (wind and ice loads are missing);
- c) the average temperature, 15°C and the wind speed of 10 m / s (the ice loads is missing);
- d) average temperature, 15°C and maximum wind speed (the ice loads is missing);
- e) maximum temperature 40°C (ambient) and 75°C (on active conductors of type AL1, AL3, AL1 / ST1A and AL3 / ST1A (wind and ice loads are missing);

	GLOBAL STANDARD	Page 49 of 69
	LATTICE STEEL SUPPORTS FOR HIGH VOLTAGE LINES	GSCS001 Rev. 00 09/12/2020

f) the temperature of formation of the ice loads -5°C and the deposition of ice loads on the component elements of the line (the wind is missing);

g) the temperature of formation of the ice loads -5°C (the wind simultaneously with the ice loads and the deposition of ice loads on the component elements of the line).

Basic wind speed $V_{b,0}$ (m / s)

From the point of view of the basic wind speed, the territory of Romania is divided into five meteorological zones A, B, C, D and E presented in figure 4 / RO.1 of SR EN 50341-2-24. The recording period of 10 minutes, 10 m above the ground; 50 years return period.

$V_{b,0}$ (m/s)

- A $\leq 25,0$
- B 25,1÷30
- C 30,1÷35
- D 35,1÷40
- E > 40

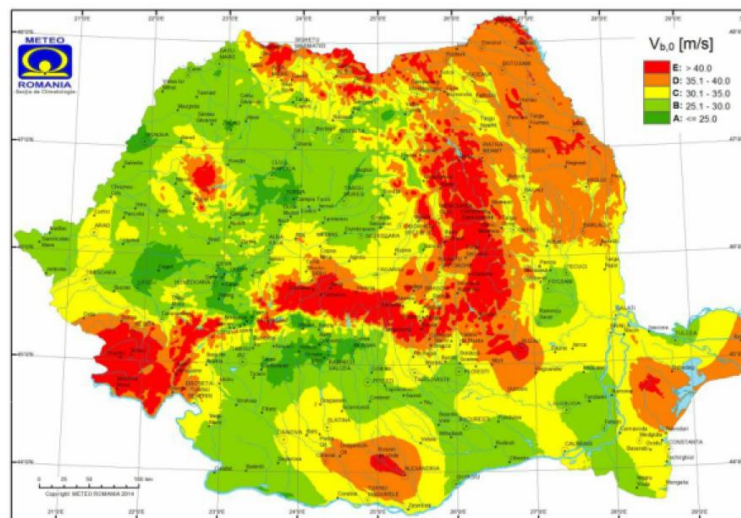

Wind speed simultaneously with ice loads $V_{b,0_ch}$ (m / s)

From the point of view of the wind speed simultaneously with the wind, the Romanian territory is divided into six meteorological zones a, b, c, d, e and f presented in figure 4 / RO.3 of SR EN 50341-2-24. The recording period of 10 minutes, 10 m above the ground; 50 years return period.

f > 40

$V_{b,0_ch}$ (m/s)

- a < 15
- b 15,1÷20
- c 20,1÷25
- d 25,1÷30
- e 30,1÷40

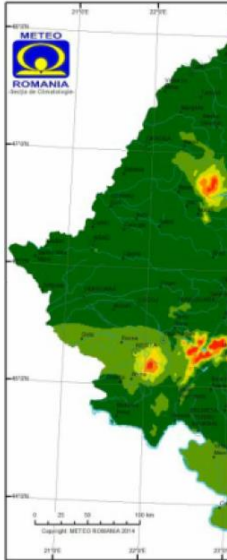

Ice loads layer thickness b_{ch} (mm)

From the point of view of the thickness of the ice loads layer, the territory of Romania is divided into eleven different colored meteorological zones on the map of figure 4 / RO.2 of SR EN 50341-2-24. The recovery period is 50 years.

b_{ch} (mm)

- 1: ≤ 15
- 2: 15,1 ÷ 20
- 3: 20,1 ÷ 25
- 4: 25,1 ÷ 30
- 5: 30,1 ÷ 40
- 6: 40,1 ÷ 60
- 7: 60,1 ÷ 80
- 8: 80,1 ÷ 100
- 9: 100,1 ÷ 150
- 10: 150,1 ÷ 200
- 11: > 200

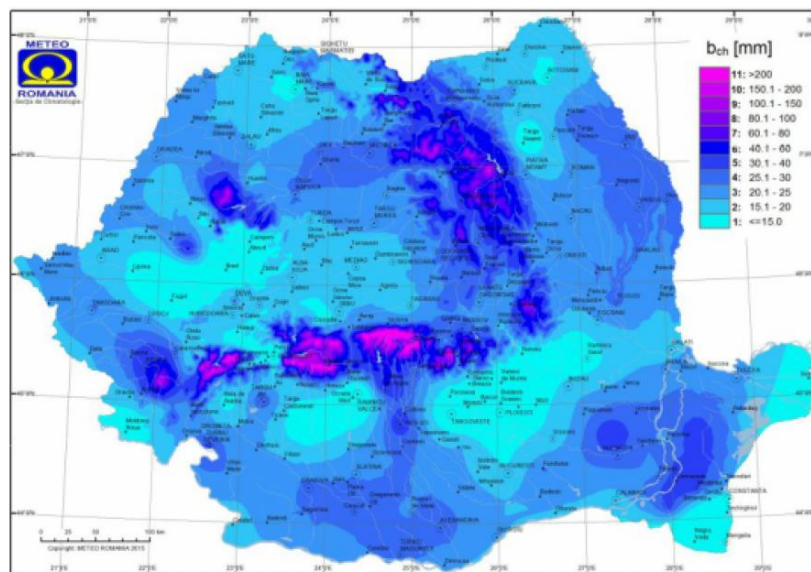

	GLOBAL STANDARD	Page 51 of 69
	LATTICE STEEL SUPPORTS FOR HIGH VOLTAGE LINES	GSCS001 Rev. 00 09/12/2020

1.2 Load and loading conditions

The columns must be designed in accordance with their use and in accordance with the loading assumptions classified in 4.12.2 / RO.5 of SR EN 50341-2-24. Limit loads are limit loads are computational loads for designing structures.

The calculation hypotheses presented in the standard SR EN 50341-2-24 in chapter 4.12. Calculation assumptions apply to the different types of lattice steel support, according to table 4 / RO.3 of the standard, considering the following details:

- a) For each functional type of lattice steel support, all hypotheses are applied independently;
- b) The loads corresponding to each hypothesis are applied simultaneously;
- c) Loads related to line angle bisectors apply only to corner lattice steel support.

Double or multi-circuit lattice steel support are calculated by applying all the assumptions when mounting circuits on both sides of the support and in case of circuits only on one side of the support.

Table 4 / RO.3-Calculation assumptions for different types of support.

No.	Functional type of lattice steel support		Load grouping	
			Fundamental (Normal)	Special (Fault)
			Calculation hypothesis	
1.	Suspension	Equipped with insulating support	N1, N2, N3, N4, N5 ¹⁾ , N6 ¹⁾ , N7	2)
		Equipped with suspension insulators (catena of insulators)	N1, N2, N3, N4, N5 ¹⁾ , N6 ¹⁾ .	A1, A2, A3
2.	Tension and corner		N1, N2, N3, N4, N8	A1, A2
3.	Terminal ³⁾		N9, N10, N11, N12	A1, A2
4.	Intervention		N1, N2	-

Note 1 - Hypotheses N5 and N6 apply to LEA (aerial electric line) 110kV metal support used in large crossings, regardless of LEA voltage.

Note 2 - The support suspension equipped with support insulators do not check in the damaged mode. At these poles, the load transmitted to the pole at the break of the conductor should not exceed 65% of the peak load, equivalent to the breaking moment of the pole, resulting from dimensioning, according to hypothesis N7.

Note 3 - At the terminal poles with several circuits, the checks are also done under the conditions of mounting only the circuits on one side of the support.

General provisions and lattice steel support geometry

The dimensions and the general dispositions of the support must be determined before the start of the structural design, considering the required electrical distances, the number of circuits, the openings of calculation, the conditions of foundation and the projects of the catena of isolators.

The lattice steel support will allow the equipment with active conductors from AI-OL185/32 mm², AL-OL240/40 mm², AL-OL 350/50mm² and AL-OL 450/75 mm² and protective conductor AI-OL-S 95/55 mm² or equivalent type OPGW 95 with 48 optical fibers, insulation made with single or double composite catena

	GLOBAL STANDARD	Page 53 of 69
	LATTICE STEEL SUPPORTS FOR HIGH VOLTAGE LINES	GSCS001 Rev. 00 09/12/2020

LOCAL SECTION H – Edesur

ANNEX A – STANDARD GRAPHS

The standard graphs included on this annex are those indicated on the table below:

Graphic Title	Load Case	C.S.	Types of Tower
Graph 1: Tower Type L and M	Load Case 1 (Wind)	1,5	L-0, L-1, L-2, L-3, M-0, M-1, M-2, M-3, M-4
Graph 1: Tower Type G and F	Load Case 1 (Wind)	1,5	G-1, G-2, G-3, G-5, G-6, F-1, F-2, F-3, F-4, F-5
Graph 1 bis: Tower Type L and M	Load Case 1 (Wind)	1,875	L-0, L-1, L-2, L-3, M-0, M-1, M-2, M-3, M-4
Graph 1 bis: Tower Type G and F	Load Case 1 (Wind)	1,875	G-1, G-2, G-3, G-5, G-6, F-1, F-2, F-3, F-4, F-5
Graph 2: Tower Type L and M	Load Case 2 (Ice, unbalanced tension)	1,2	L-0, L-1, L-2, L-3, M-0, M-1, M-2, M-3, M-4
Graph 2: Tower Type G and F	Load Case 2 (Ice, unbalanced tension)	1,2	G-1, G-2, G-3, G-5, G-6, F-1, F-2, F-3, F-4, F-5
Graph 3: Tower Type L and M	Load Case 3 (break of conductor)	1,2	L-0, L-1, L-2, L-3, M-0, M-1, M-2, M-3, M-4
Graph 3: Tower Type G and F	Load Case 3 (break of conductor)	1,2	G-1, G-2, G-3, G-5, G-6, F-1, F-2, F-3, F-4, F-5
Graph 4: Tower Type L and M	Load Case 4 (break of earth wire)	1,2	L-0, L-1, L-2, L-3, M-0, M-1, M-2, M-3, M-4
Graph 4: Tower Type G and F	Load Case 4 (break of earth wire)	1,2	G-1, G-2, G-3, G-5, G-6, F-1, F-2, F-3, F-4, F-5
Graph 3 (End of Line Funtion): Tower Type F	Load Case 3F (break of conductor, end of line funtion)	1,2	F-1, F-2, F-3, F-4, F-5
Graph 4 (End of Line Funtion): Tower Type F	Load Case 4F (break of earth wire, end of line funtion)	1,2	F-1, F-2, F-3, F-4, F-5



Graph 1: Tower Type L and M

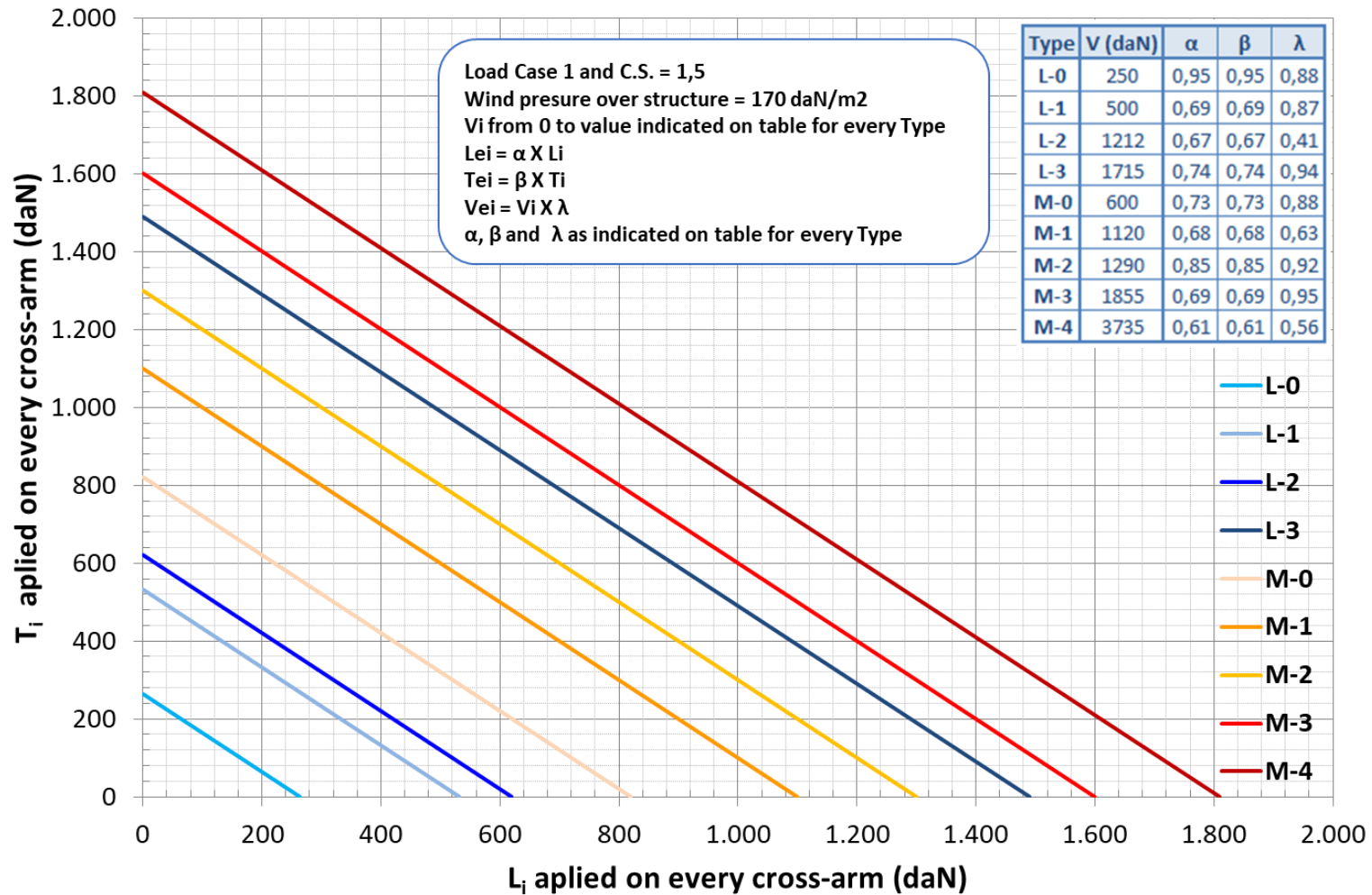



Graph 1: Tower Type G and F

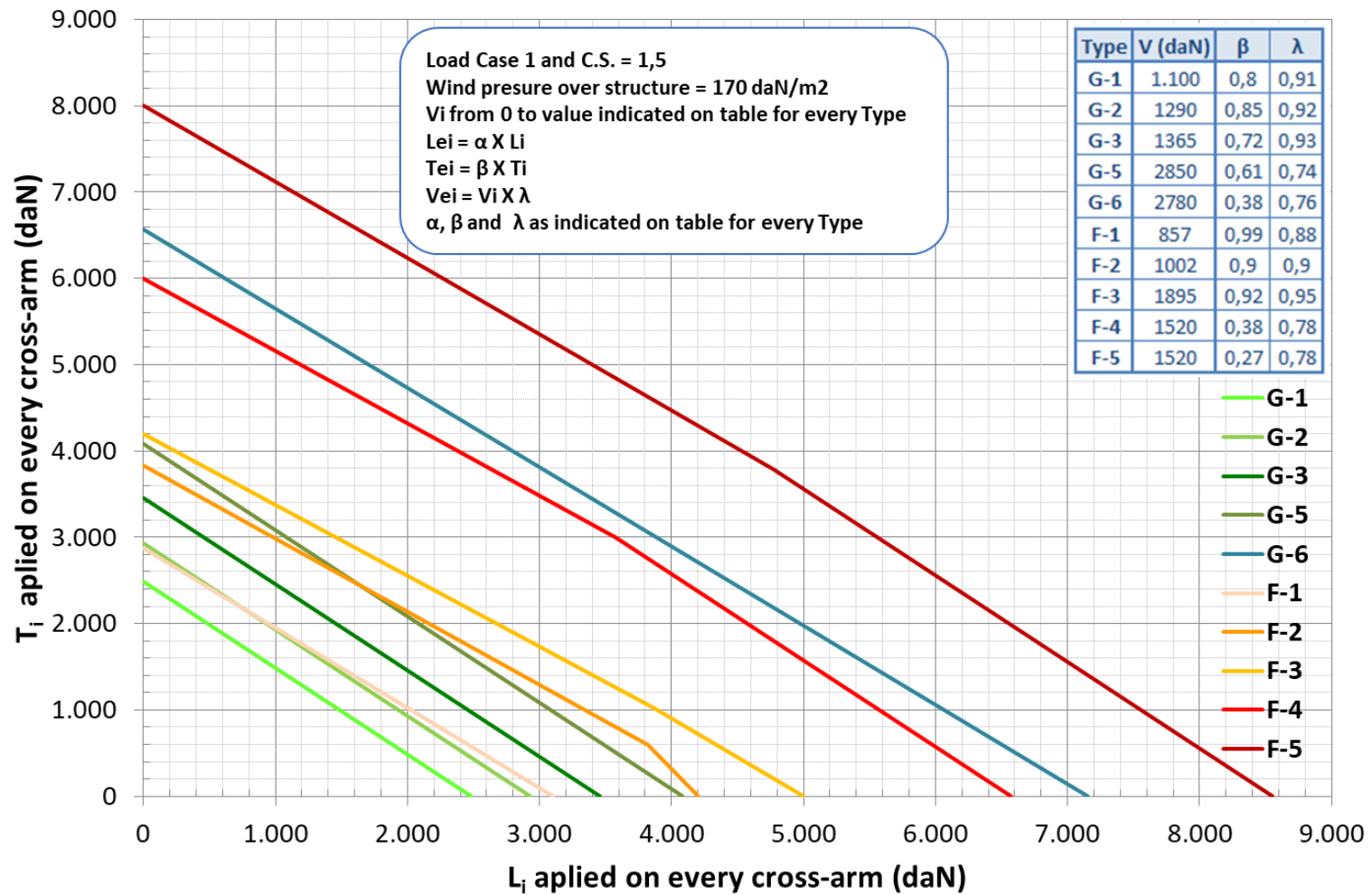



Graph 1 bis: Tower Type L and M

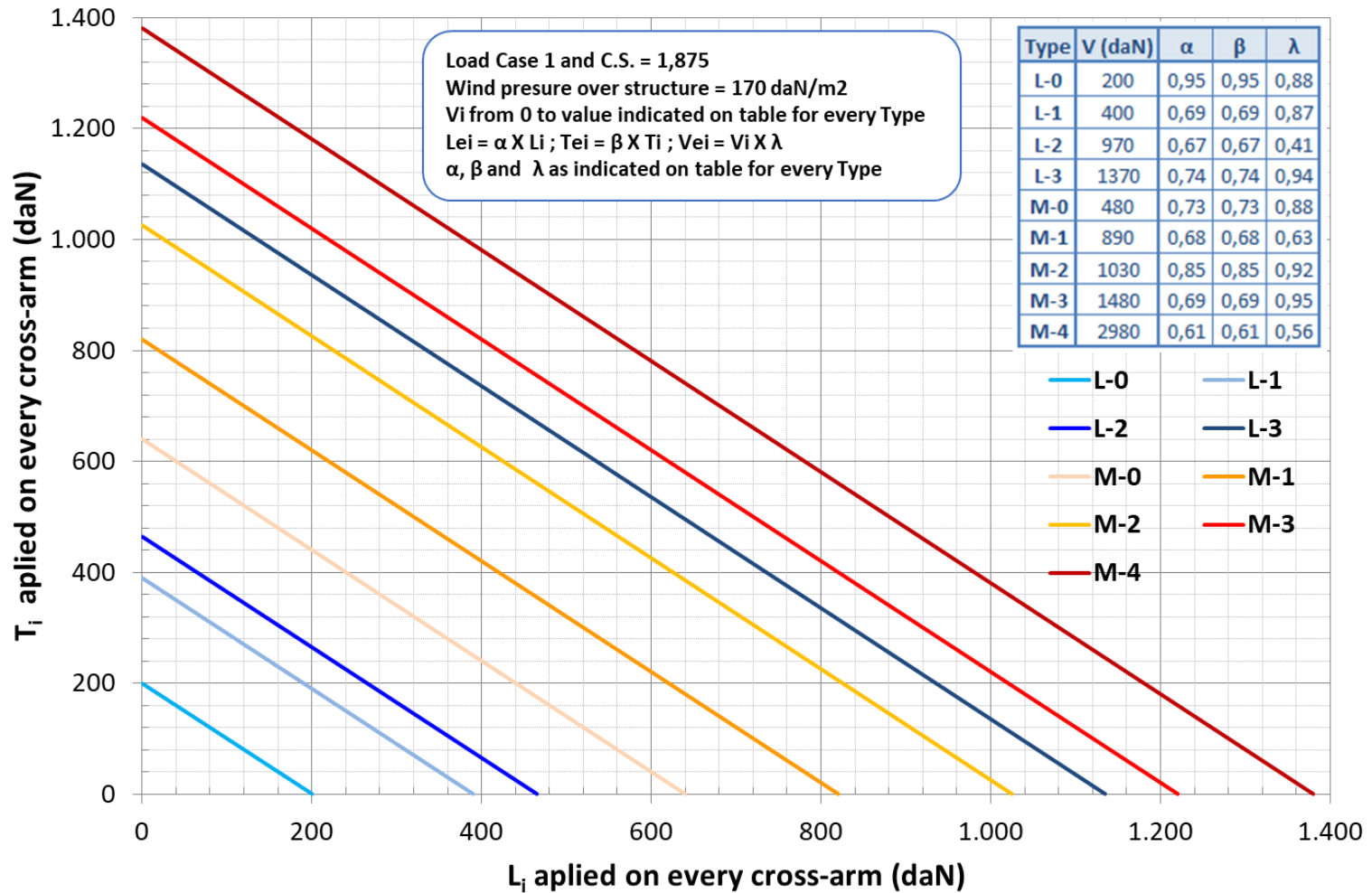



Graph 1 bis: Tower Type G and F

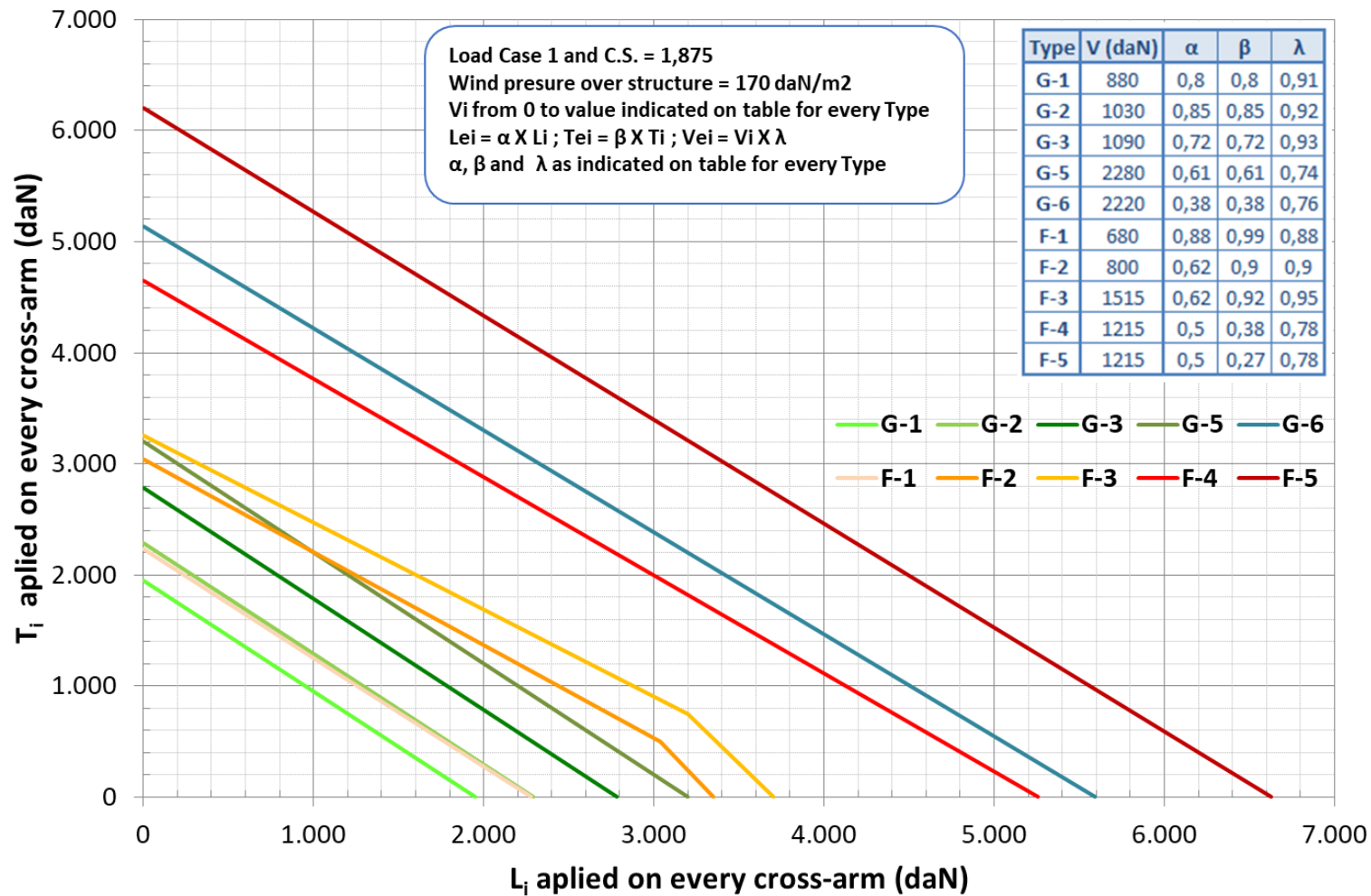



Graph 2: Tower Type L and M

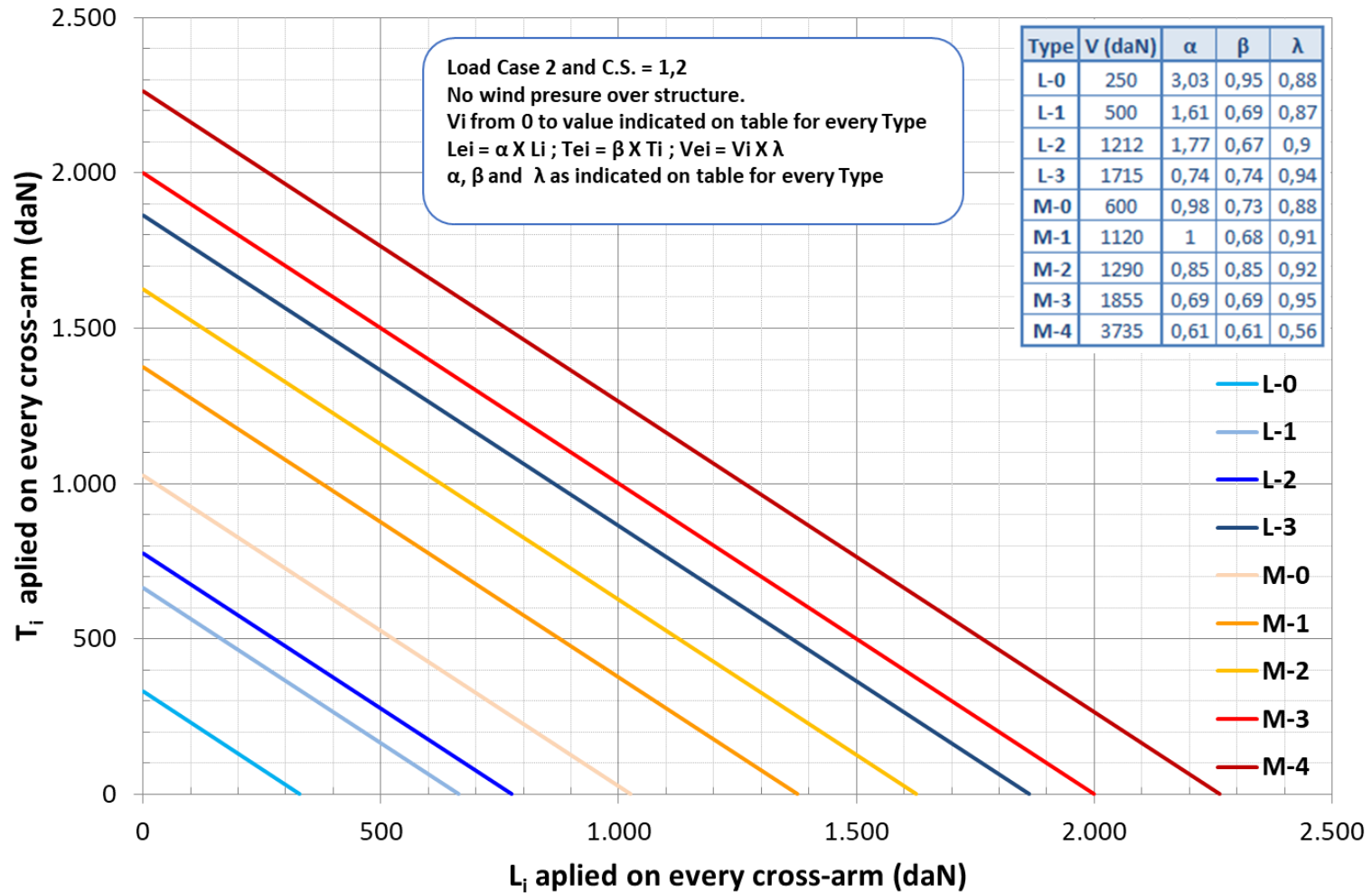



Graph 2: Tower Type G and F

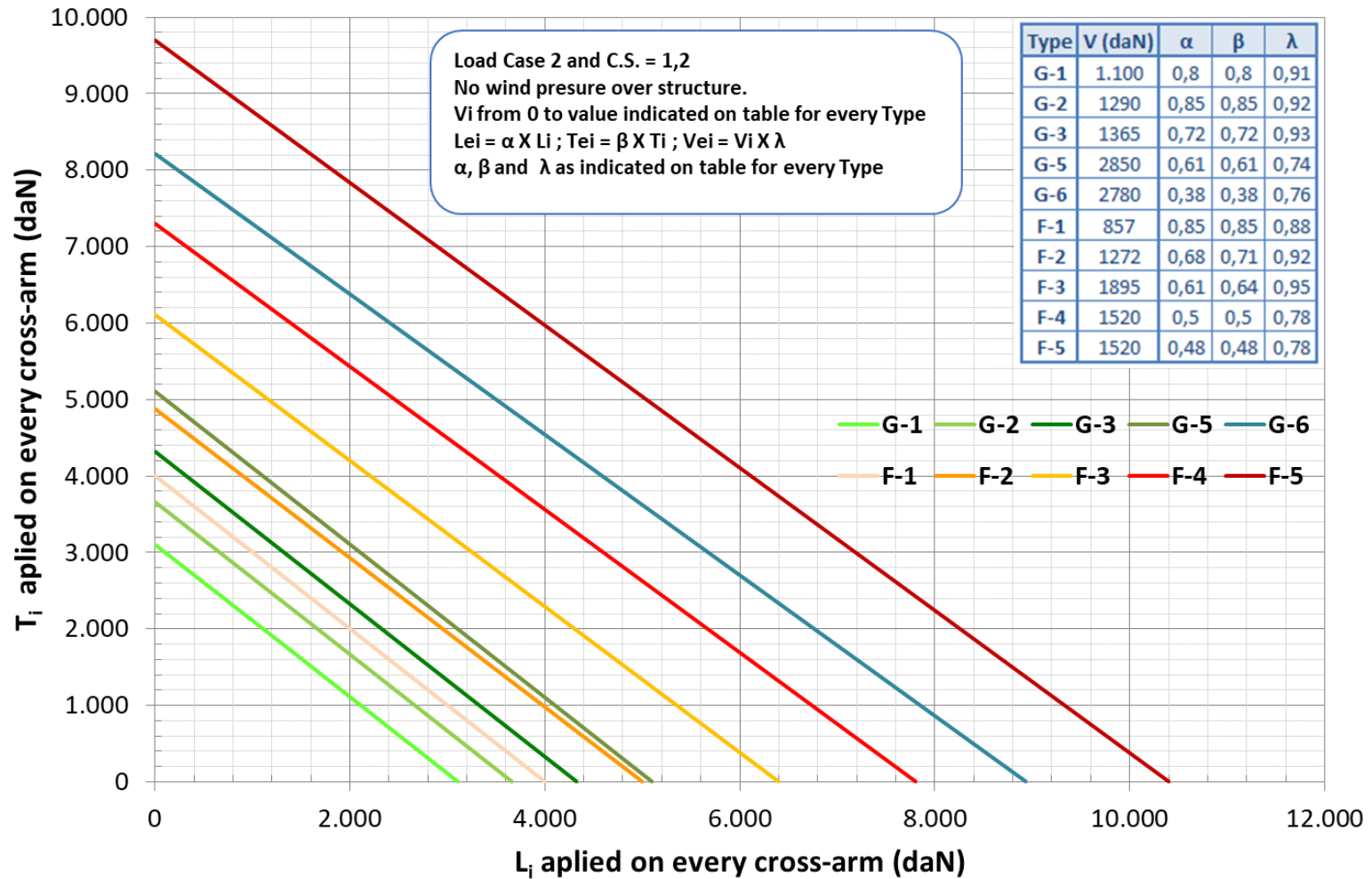



Graph 3: Tower Type L and M

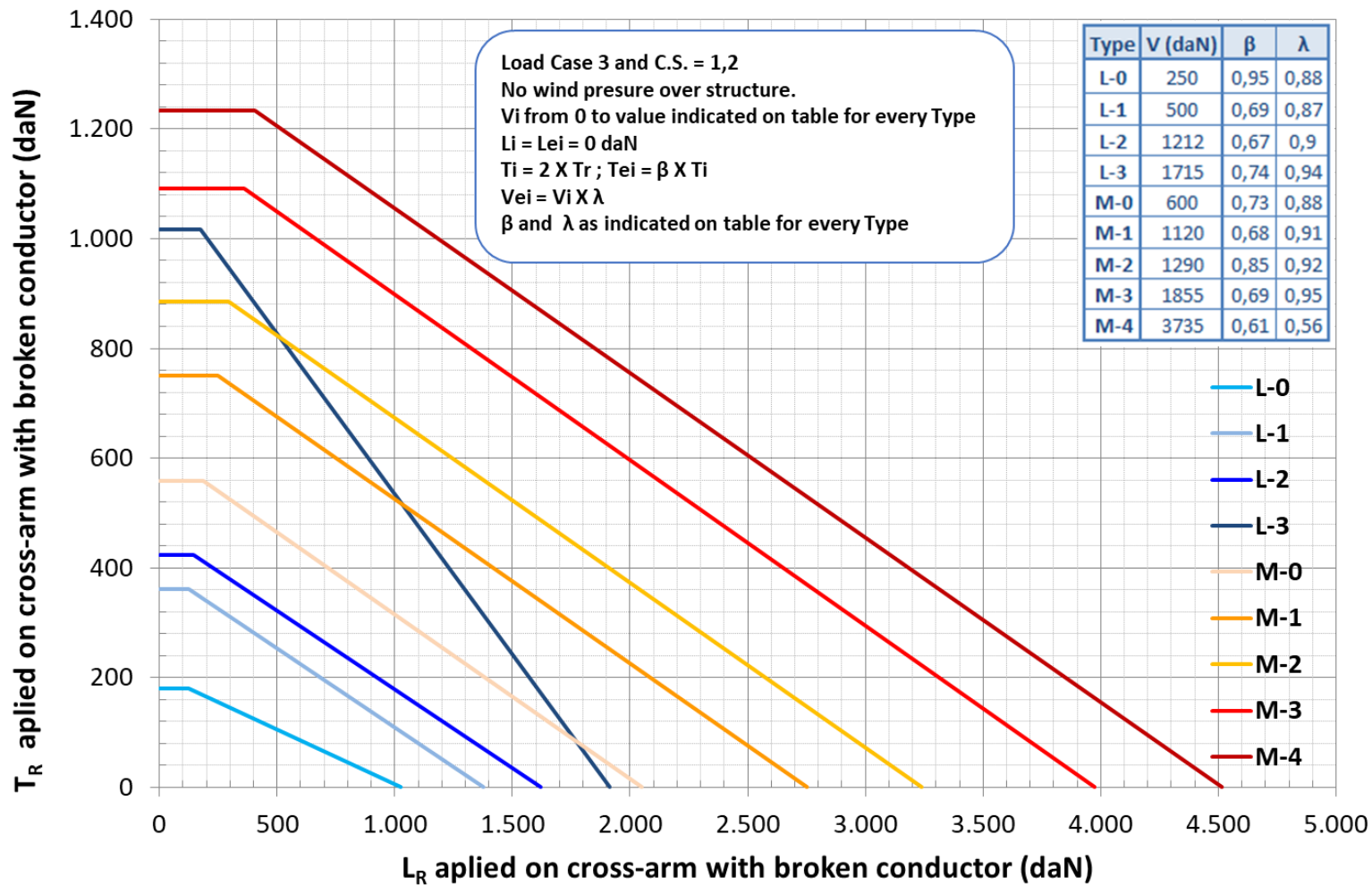



Graph 3: Tower Type G and F

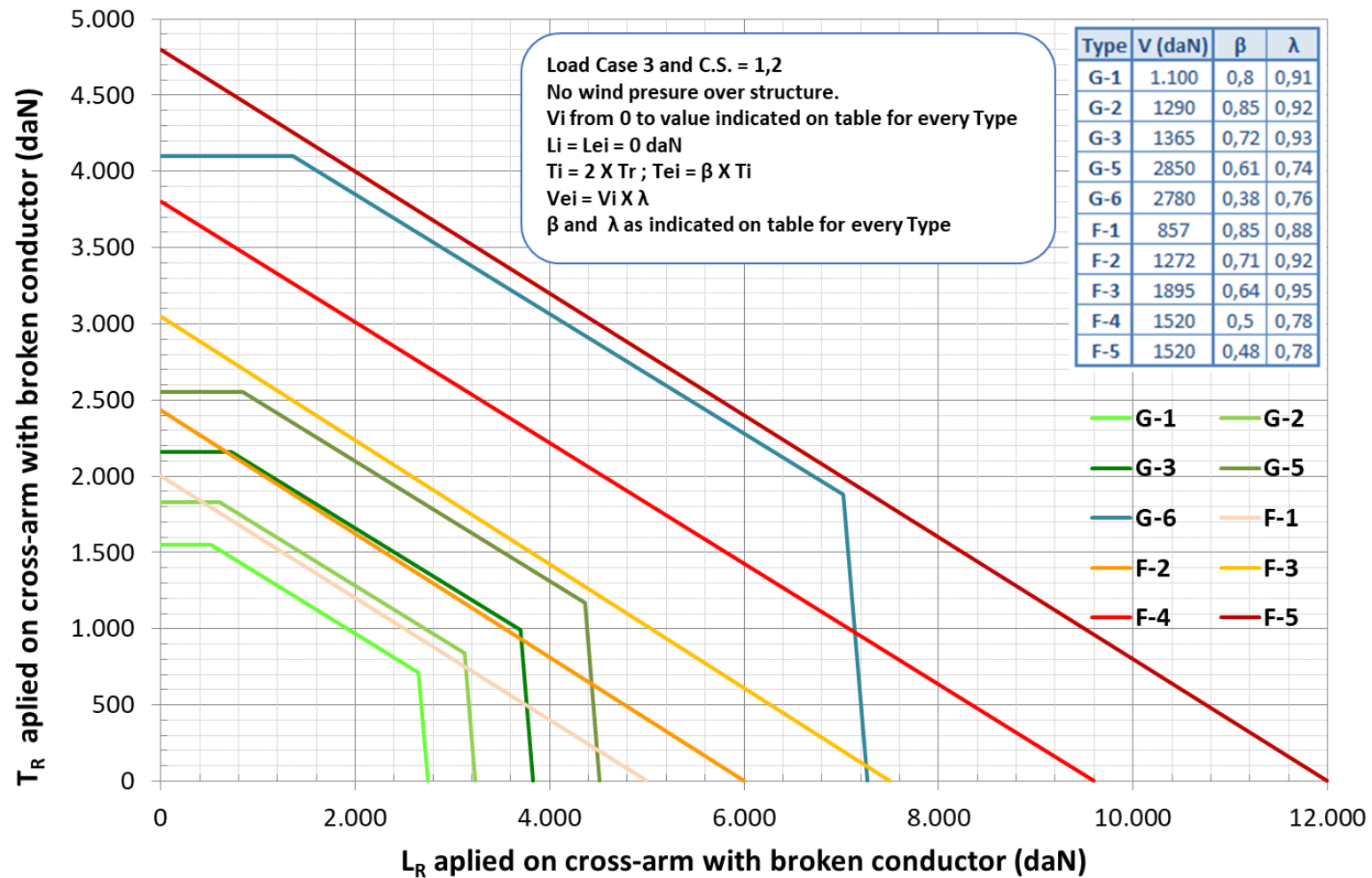



Graph 4: Tower Type L and M

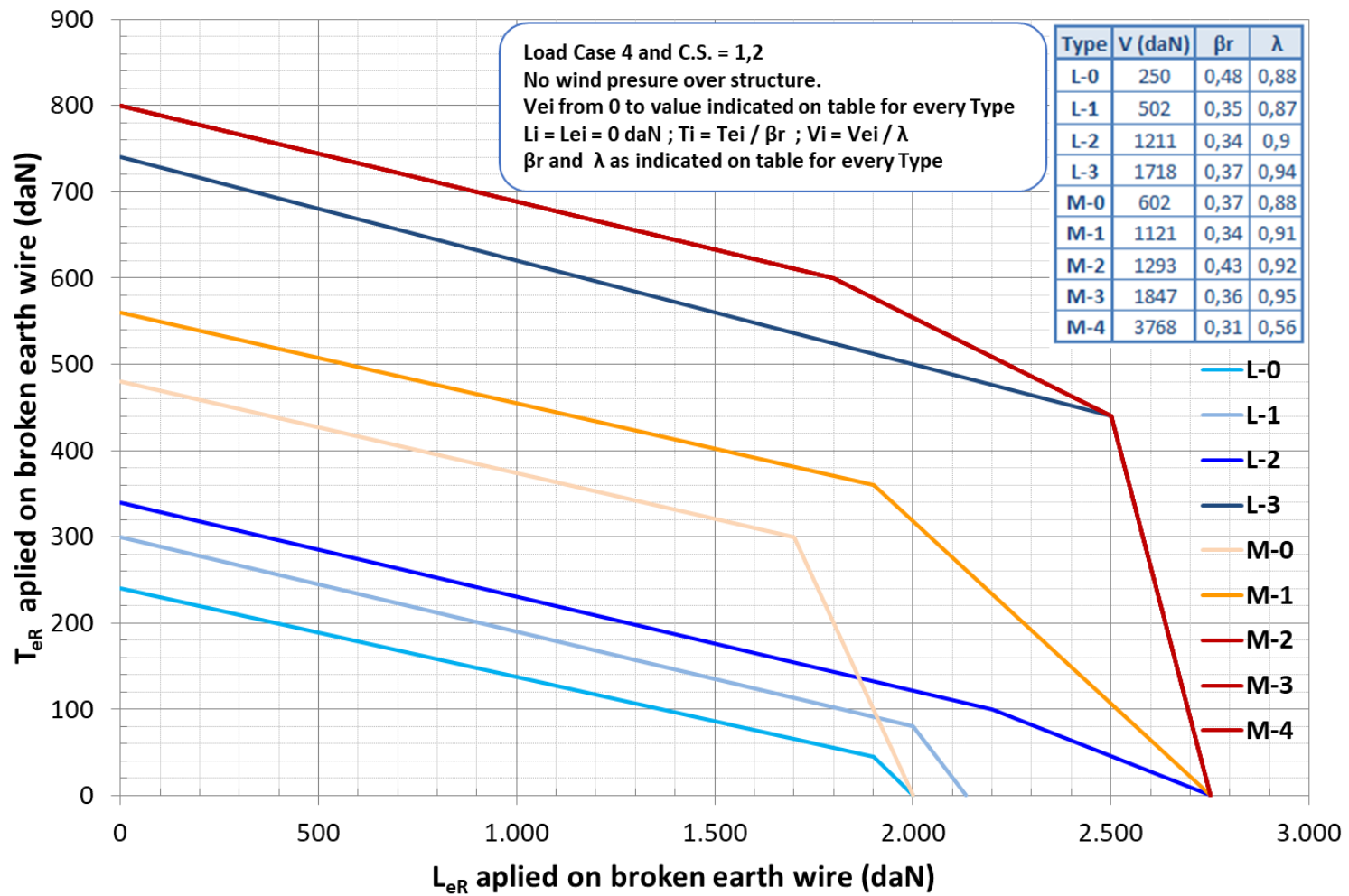



Graph 4: Tower Type G and F

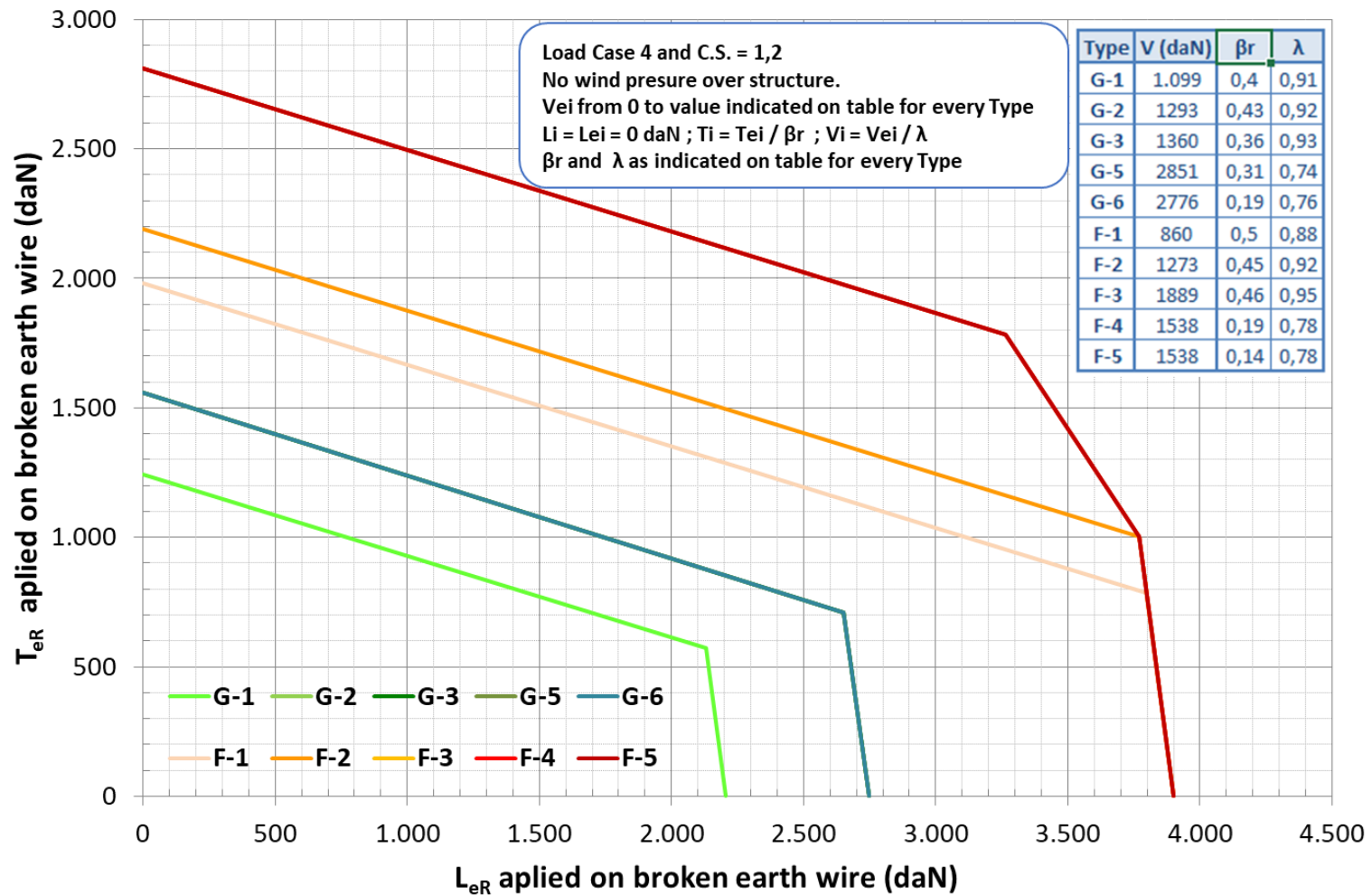



Graph 3 (End of Line Funtion): Tower Type F

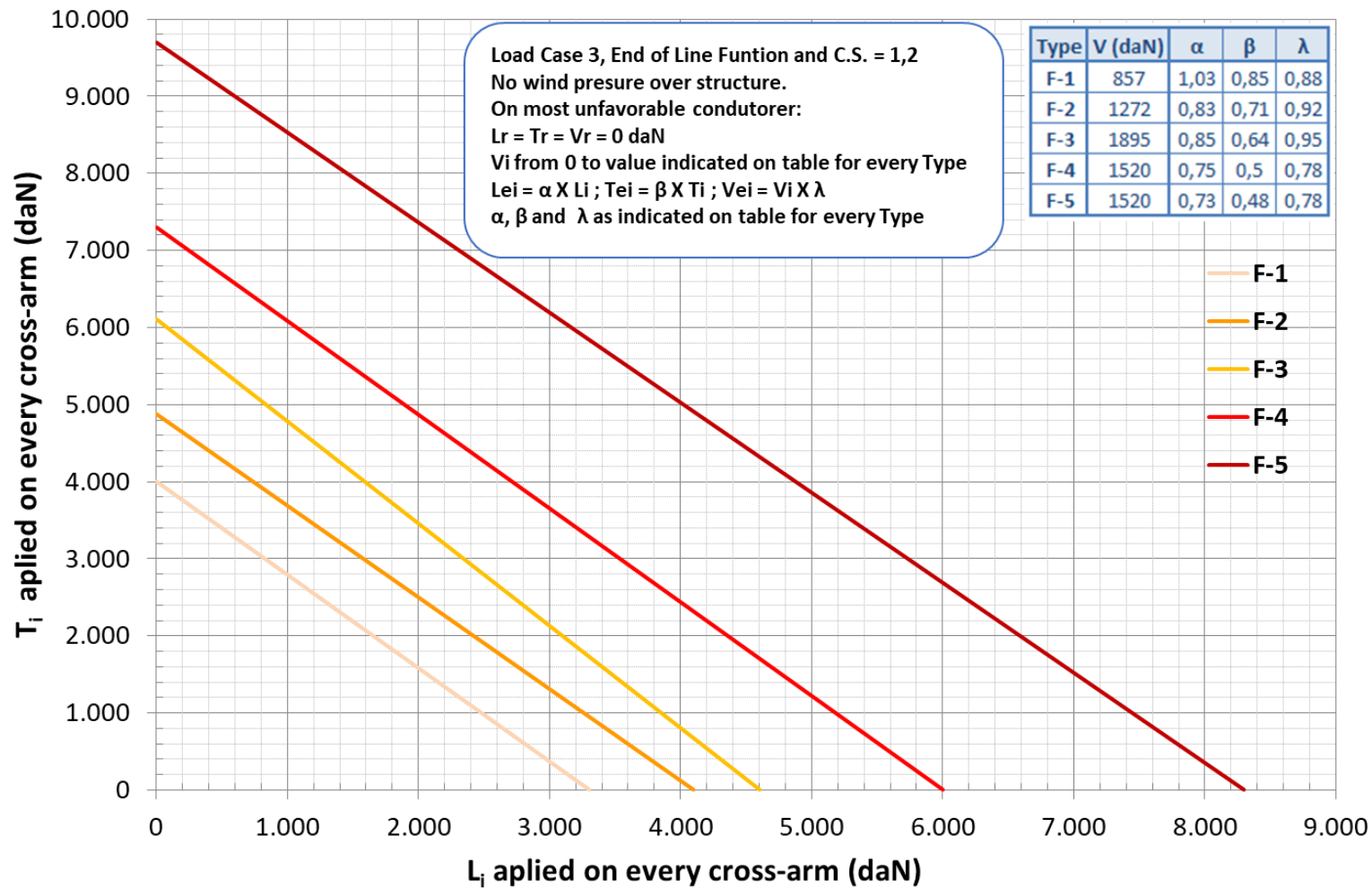



Graph 4 (End of Line Funtion): Tower Type F

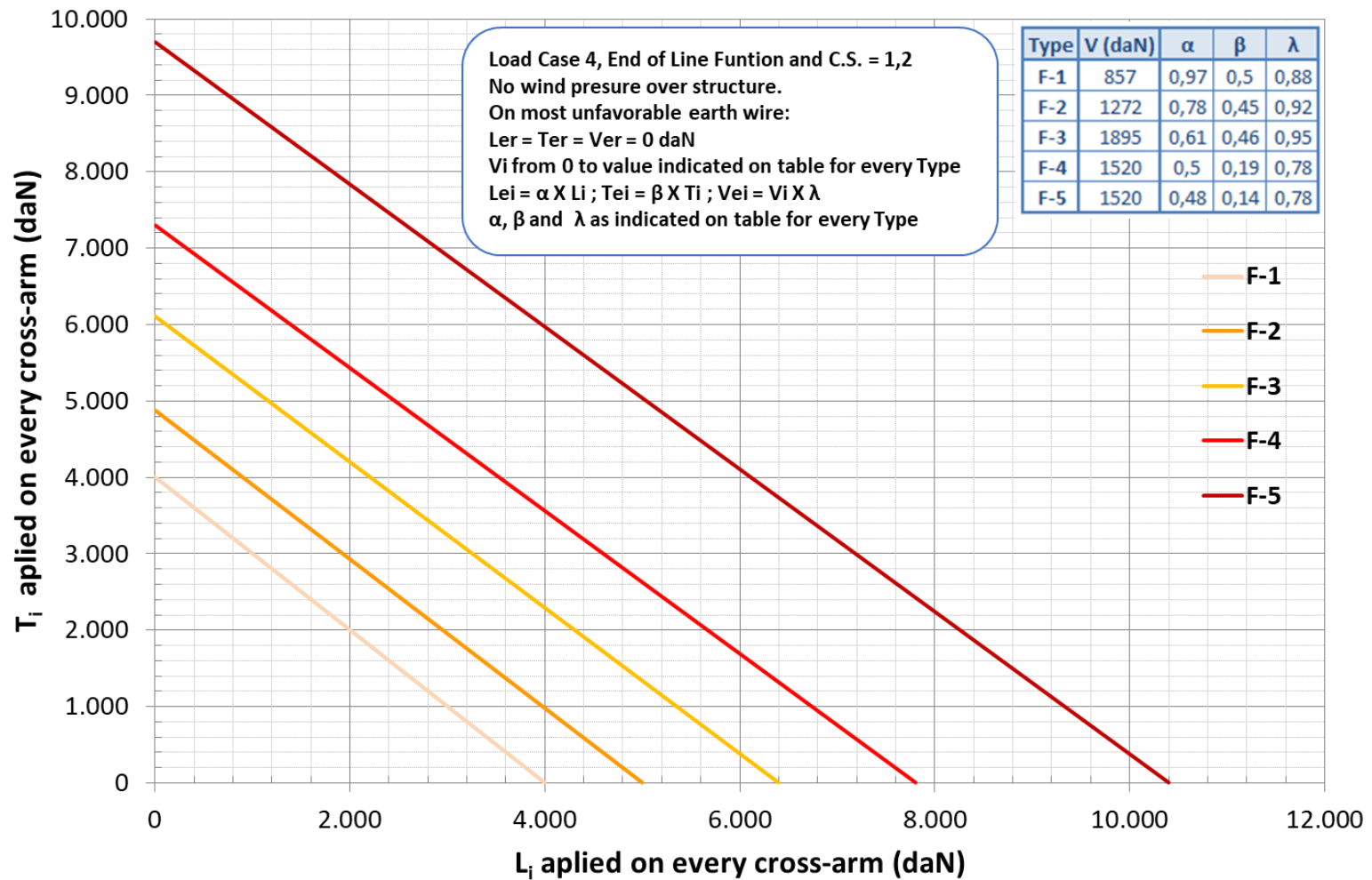

	GLOBAL STANDARD	Page 67 of 69
	LATTICE STEEL SUPPORTS FOR HIGH VOLTAGE LINES	GSCS001 Rev. 00 00/00/0000

ANNEX B - TECHNICAL CHECK-LIST

Not applicable

	GLOBAL STANDARD	Page 68 of 69
	LATTICE STEEL SUPPORTS FOR HIGH VOLTAGE LINES	GSCS001 Rev. 00 00/00/0000

ANNEX C – LIST OF GLOBAL STANDARD CODES

